

**FIRST  
EDITION**



*Union Special*<sup>®</sup>  
INDUSTRIAL SEWING EQUIPMENT

**CATALOG NO. 90L**

---

**STYLES**

**51000 A**

**51100 N**

---

**LEFT AND RIGHT HAND BAG MACHINES**



Catalog No. 90 L

LIST OF PARTS

Left and Right Hand  
Bag Machines

STYLES

51000 A            51100 N

The parts listed in this catalog are  
furnished at list prices for repairs only.

First Edition

Copyright 1942  
By  
Union Special Machine Co.  
Rights Reserved In All Countries

Union Special Machine Company  
Chicago, U.S.A.

Printed in U.S.A.

## OFFICES, SERVICE STATIONS, FOREIGN DISTRIBUTORS

- ★ CHICAGO, ILL. Union Special Machine Co., 404 N. Franklin St. Main Office and Factory. T. S. Whitsel, Gen. Sales Mgr. J. W. McLain, Asst. Gen. Sales Mgr. L. C. Morris, Foreign Sales Mgr. A. E. Brauch, Manager, Technical Sales Division. *Tel. Superior 6920.*
- ALLENTOWN, PA. 1055 N. 22nd St. B. C. Mathews. *Tel. 2-1330.*
- ★ ATLANTA, GA. Spring at Biltmore Pl. P. T. McLendon, Mgr. *Tel. Atwood 2733 and 2734.*
- BALTIMORE, MD. 34 S. Eutaw St. C. D. Mairs. *Tel. Plaza 8499.*
- ★ BOSTON, MASS. 210 South St. Wm. E. Palm, Mgr. *Tel. Liberty 0147-48.*
- ★ CINCINNATI, O. 422 Temple Bar Bldg. W. E. LeRoy, Mgr. *Tel. Parkway 2521.*
- CLEVELAND, O. 1276 W. Third St. K. D. Bear. *Tel. Main 9657.*
- COLUMBUS, OHIO. 1669 Elmwood Ave. R. J. Lindhorst. *Kingswood 5520.*
- DALLAS, TEXAS. 2719 N. Haskell St. J. H. Muir. *Tel. 8-1084.*
- DETROIT, MICH. John Lux, 11832 Ohio Ave. *Tel. Hogarth 5289.*
- FT. WORTH, TEX. 912 Morningside Drive. H. M. Petershagen. *Tel. 4-7776.*
- GREENSBORO, N. C. 4109 Walker Ave. L. F. McGwier. *Tel. 6301.*
- GREENVILLE, S. C. 601 Cleveland St. O. S. Bachelor. *Tel. 5404W.*
- INDIANAPOLIS, IND. B. L. Rogers, 3731 N. Tacoma Ave. *Tel. Cherry 2521.*
- JACKSON, MISS. M. O. Moulton, 909 Whitworth St. *Tel. 2-2924.*
- JOHNSON CITY, N. Y. 49 Cherry St. Wm. Browne. *Tel. 7-3179.*
- KANSAS CITY, MO. 3616 E. 59th St. T. O. Biggers. *Tel. Highland 5797.*
- LOS ANGELES, CAL. 119 E. Pico Blvd. C. E. Downs. *Tel. Prospect 5636.*
- MINNEAPOLIS, MINN. 3608 27th Ave. So. R. W. Bredahl. *Tel. Drexel 3331.*
- MONTREAL, QUE. Blvd. St. Laurent at Prince Arthur. S. J. Storey. *Tel. LA 7944.*
- NASHVILLE, TENN. Observatory Drive. W. J. Brauch. *Tel. 8-5123.*
- NEWARK, N. J. 60 Park Place. H. K. Lanning. *Tel. Market 3-3123.*
- NEW HAVEN, CONN. C. H. Verdeur, 500 Eastern St.
- NEW ORLEANS, LA. 312 Chartres St. J. A. Boyette. *Tel. Raymond 1926.*
- ★ NEW YORK, N. Y. 116 E. 27th St. Wm. Bleicher, Mgr. *Tel. Murray Hill 4-4665 or 4-4666.*
- ★ PHILADELPHIA, PA. 1316 Arch St. T. M. Murphey, Mgr. *Tel. (Bell) Locust 1023 & 1024, (Key.) Race 1078.*
- PITTSBURGH, PA. 3265 Raleigh Ave. R. G. Timm. *Tel. Locust 1086.*
- PORTLAND, ORE. I. C. Looper. 1903 N. E. Weidler St. *Tel. Webster 1405.*
- POTTSVILLE, PA. 20 South Center St. L. J. Perrin. *Tel. 2508.*
- ★ ST. LOUIS, MO. 1700 Olive St. E. E. Gratsch, Mgr. *Tel. Chestnut 2368.*
- ★ SAN FRANCISCO, CAL. 371 4th St. Ben W. Merz, Mgr. *Tel. Garfield 7999.*
- ★ TORONTO, ONT. 137 Wellington St. G. A. Rundle, Mgr. *Tel. Adelaide 2909.*
- UTICA, N. Y. 33 Leslie St. P. J. Steeper. *Tel. 4-6422.*
- WATERFORD, N. Y. 22 Fourth St. A. J. Brown. *Tel. 467.*
- WINNIPEG, MAN. 1065 Dominion St. Walter Baldwin. *Tel. 24244.*
- WORCESTER, MASS. 1 Einhorn Rd. F. E. Hodtum. *Tel. 2-1412.*
- YORK, PA. 837 Florida Ave. Wm. Denholm. *Tel. 64196.*

### OVERSEAS

- AFRICA—Capetown, Durban, Johannesburg, Port Elizabeth, South Africa. Port Louis, Mauritius. Cairo, Egypt.
- ASIA—Calcutta, India. Surabaya, D. E. I.
- ASIA MINOR—Tel Aviv, Palestine, Beirut, Syria. Baghdad, Iraq. Teheran, Iran.
- AUSTRALIA—Brisbane, Melbourne, Perth, Sydney.
- EUROPE—Leicester, London and Manchester, England. Oporto, Portugal. Dundee and Glasgow, Scotland. Barcelona, Spain. Boras, Stockholm and Orebro, Sweden. Zurich, Switzerland.
- NEW ZEALAND—Auckland, Christchurch, Dunedin, Wellington.
- NORTH AMERICA—Havana, Cuba. Mexico City and Monterrey, Mexico. Jamaica, B. W. I. San Juan, P. R.
- PACIFIC ISLANDS—Honolulu, Hawaii.
- SOUTH AMERICA—Buenos Aires, Argentina. Porto Alegre, Sao Paulo, Recife, Brazil. Santiago, Chile. Barranquilla, Bogota, Medellin, Colombia. Guayaquil, Ecuador. Lima, Peru. Montevideo, Uruguay. Caracas, Venezuela.

\*MAIN OFFICES

## FOREWORD

The one dominating idea back of "Union Special" is to build the best industrial sewing machines in the world. Our new line of high speed flat bed right and left hand bag machines in Classes 51000 and 51100, equipped with enclosed type oiling system for looper drive eccentric and crank is a pronounced achievement along these lines. All parts are made to gauges with exceedingly close limits.

It is our constant aim to furnish carefully prepared information that will enable the customer to secure all possible economies and advantages from the use of Union Specials. On the pages which follow will be found illustrations and descriptions of the parts for Styles 51000 A and 51100 N.

Additional catalogs, containing information relative to these machines, and which will be furnished on request, are listed below.

Catalog No. 29	Accessories Manual
Catalog No. 45	Needle Manual
Catalog No. 45 A	Price List of Needles
Catalog No. 89	Instructions for installing and operating
Form 357	Engineering Department Adjusting Instructions. Specify the style of machine for which the Adjusting Instructions are required.

In all manufacturing centers will be found Union Special representatives, who will cooperate with those who desire in planning and estimating their requirements.

UNION SPECIAL MACHINE COMPANY

Engineering Department

## IDENTIFICATION OF MACHINES

Each Union Special carries a style number which is stamped in the name plate on the machine. Style numbers are classified as standard and special. Those which are standard have one or more letters suffixed, but never contain the letter "Z". Example: 51100 N. Style numbers containing the letter "Z" are special. When only minor changes are made in a standard machine a "Z" is merely suffixed to the respective standard style number. Example: 51100 NZ.

Styles of machines similar in construction are grouped under a class number which differs from the style numbers in that it contains no letters. Example: 51100.

### APPLICATION OF CATALOG

This catalog applies only to the standard styles of machines as listed herein. It can also be applied with discretion to the special machines covered by these classes.

#### STYLES OF MACHINES IN CLASS 51000

Enclosed Type Left Hand Flat Bed One Needle Machine

51000 A For seaming valve multi-wall paper bags, upper and under feed, stitch range 7 to 3 1/2 per inch, enclosed type oiling system for looper drive eccentric and crank, Type 947 G needle.

51000 Z A special style similar to the standard styles in Class 51000, but differing in one or more of its component parts.

#### STYLES OF MACHINES IN CLASS 51100

Enclosed Type Right Hand Flat Bed One Needle Machine

51100 N For seaming valve multi-wall paper bags, upper and under feed, stitch range 7 to 3 1/2 per inch, enclosed type oiling system for looper drive eccentric and crank, Type 947 G needle.

51100 Z A special style similar to the standard styles in Class 51100, but differing in one or more of its component parts.

## NEEDLES

### TYPE NUMBERS AND SIZES

Each needle has a type number and size number. The former denotes the kind of shank, point, length, groove, finish, and other details. The latter denotes the largest diameter of the blade, measured in thousandths of an inch midway between the shank and eye, and is stamped in the needle shank. Collectively, the type number and size number is the complete symbol.

To have orders promptly and accurately filled, the empty package, a sample needle, or the type and size numbers should be given. See marks on packages. An intelligent order would read as follows: "1000 Needles Type 947 G Size 073". The type number of the needles most commonly used in the styles of machines covered by this catalog is listed below. Set opposite the type number is the description of the needle.

Type No.	Description
947 G	Round shank, spear point, long, double groove, ball eye, spotted, chromium plated- sizes 067, 073, 080.

### ORDERING REPAIR PARTS

#### PLATES

Illustrations of parts similar in appearance, and, to some extent, component parts of the same subdivision of the mechanism, are grouped according to scale.

When a part is made in two or more sizes, usually only one illustration is shown. In ordering these parts, the additional information requested under these illustrations, such as, "specify length" or "specify size", must be furnished.

#### LIST OF PARTS

The list of parts describes each part and its principal uses. Always check the symbol against its description before ordering. It is not necessary to furnish the plate number.

When a part is used, or can be used, in all machines covered by this catalog, no specific use is mentioned in the description.

For convenience in ordering, minor parts such as screws, nuts, and similar articles are repeated after each major part.

(-) A dash in the "plate number" column of the list of parts denotes the absence of an illustration.

(‡) A double dagger in the "symbol to order by" column denotes that the component parts cannot be furnished separately. Due to the high speed of these machines it is impossible for these associated parts to be fitted a second time and make a serviceable job.

## ORDERING REPAIR PARTS (Continued)

### IDENTIFYING PARTS

Where the construction permits, each part is stamped with its part number. Some of the smaller parts are stamped with an identification letter to distinguish them from parts similar in appearance.

All part numbers represent the same part, regardless of the catalog in which they appear.

### SUPPLIES

All supplies, including taps, reamers, belting, belt hooks, belt fasteners, screw drivers, wrenches and powdered oil stone will be promptly furnished.

### USE GENUINE NEEDLES AND REPAIR PARTS

Success in the operation of these machines can be secured only by the use of genuine Union Special Needles and Repair Parts as furnished by the Union Special Machine Company, its subsidiaries and authorized distributors. Obviously, it is to our interest to maintain the reputation of Union Specials by furnishing the very best goods obtainable. They are designed according to the most approved engineering principles, and are made with the utmost precision.

Genuine needles are put up in packages marked at the top "Trade 'UNION SPECIAL' mark". Genuine repair parts are stamped with a reproduction of the well known two padlocks with a link connecting the shackles.

### TERMS

Prices are strictly "net cash" and subject to change without notice. All shipments are forwarded at the buyer's risk f.o.b. shipping point. Parcel post shipments are insured unless otherwise directed. A charge is made to cover the postage and insurance.



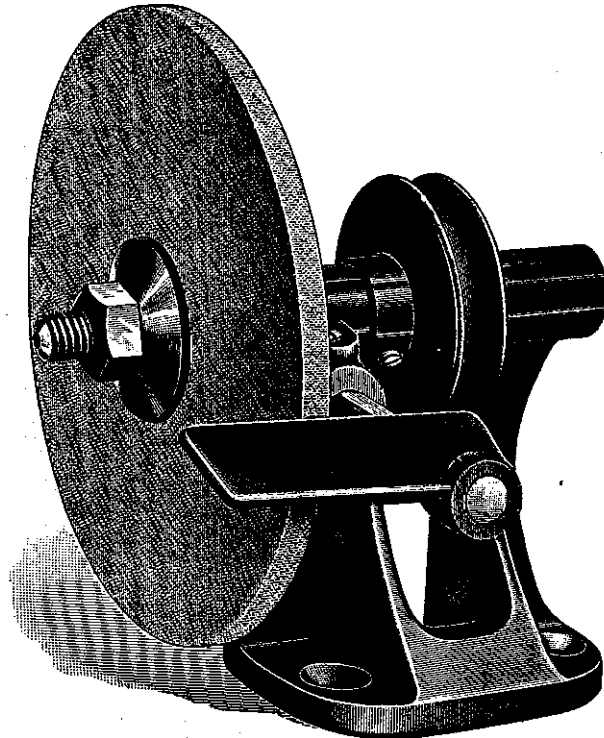

21394  
Utility Grinder

Plate 1 - Full Size

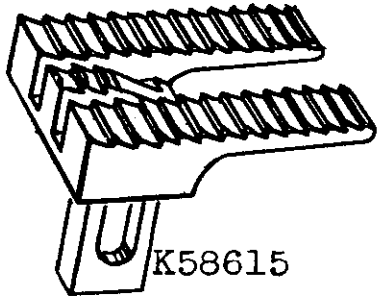

K58615

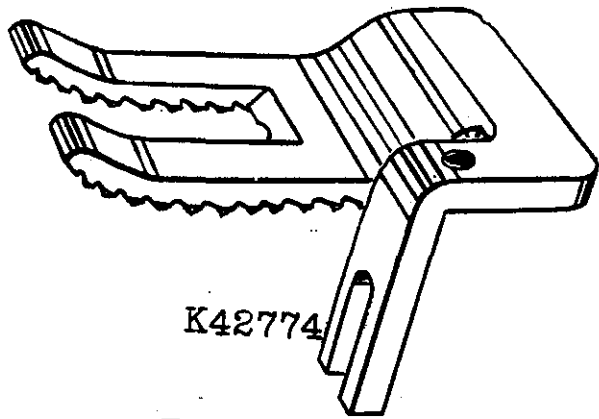

K42774

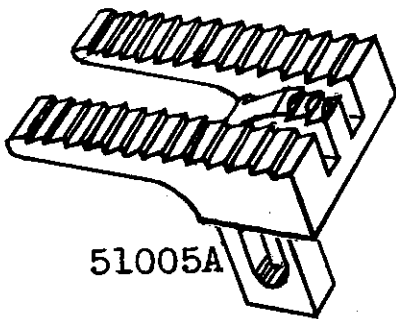

51005A

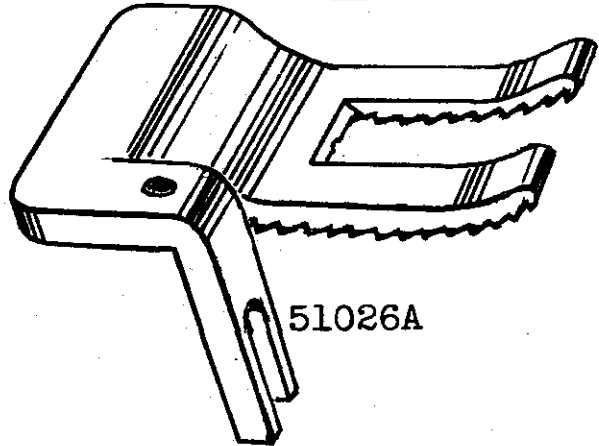

51026A

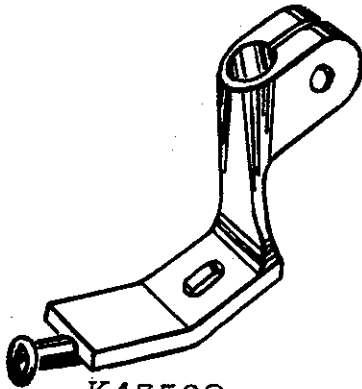

K43502

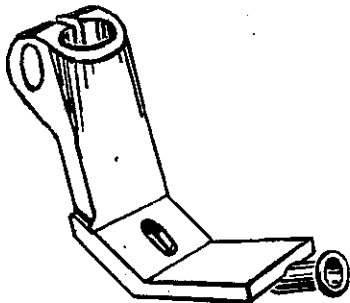

51020A

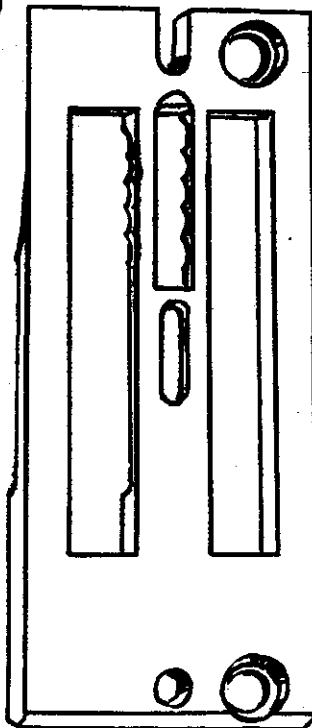

51024A



K58614

Plate 2 - Full Size

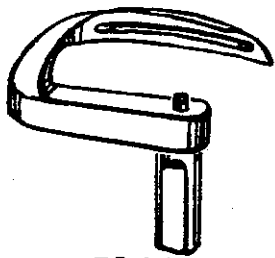

51008A

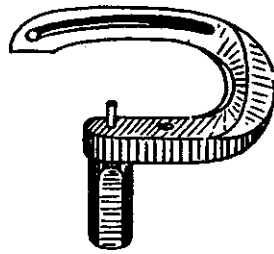

51108D

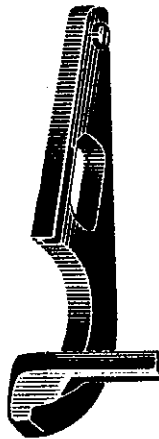

51225

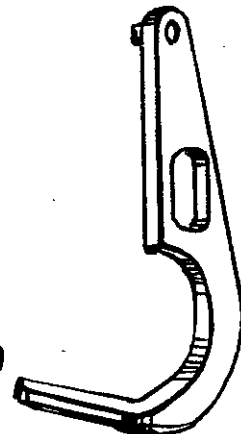

51025A



51010A



51110D

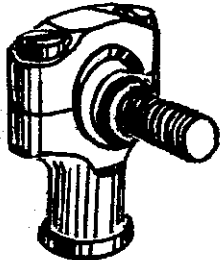

51041

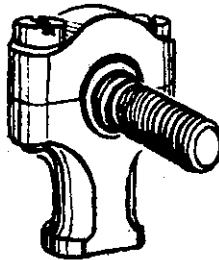

51041E

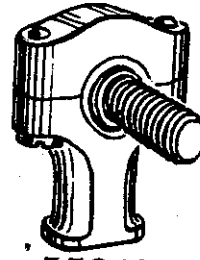

55241N

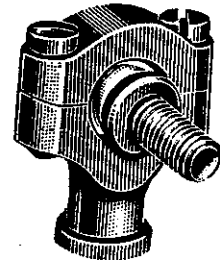

51241D

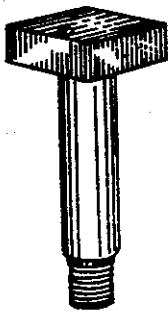

51136E

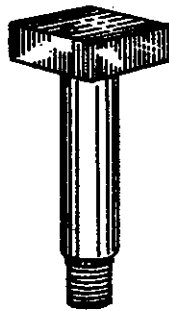

51036

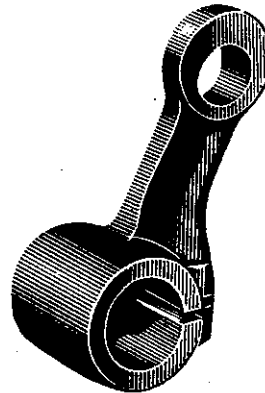

51244B

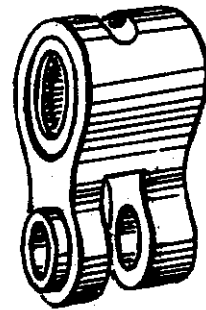

51236E

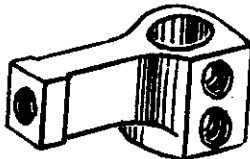

51051

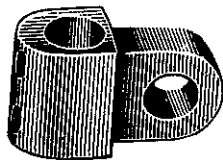

35759

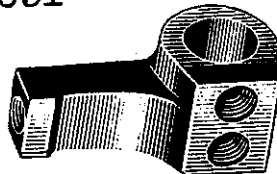

51751

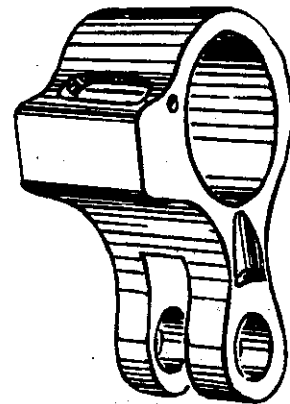

51145

Plate 3 - Full Size



Plate 4 - Full Size

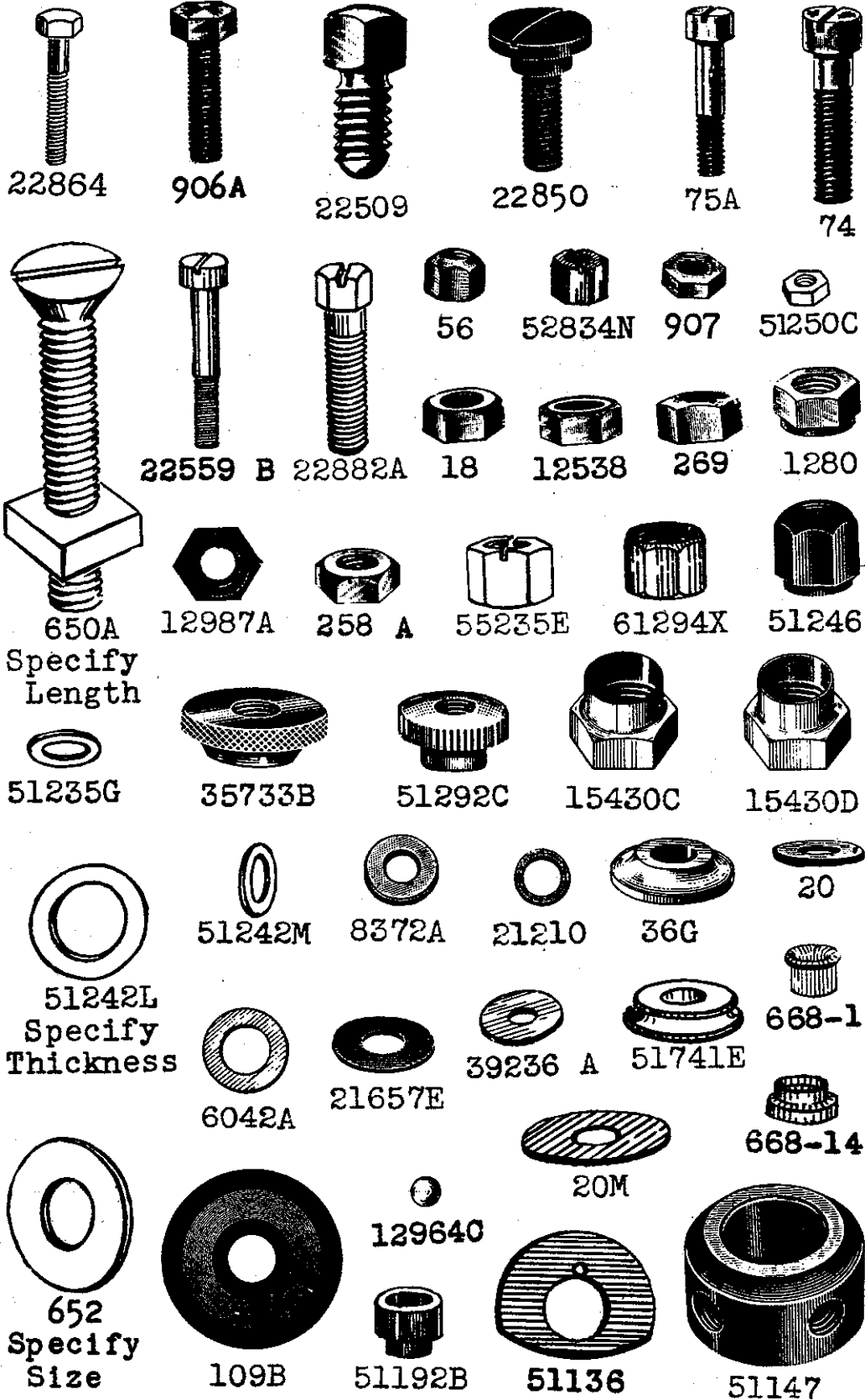
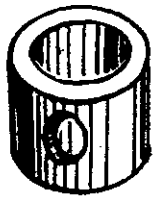
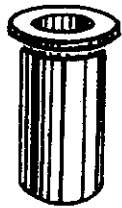

Plate 5 - Full Size



51242Q



51236F



K56760



51242R



51242S

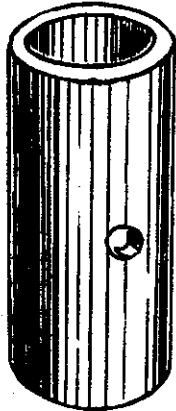

51250A

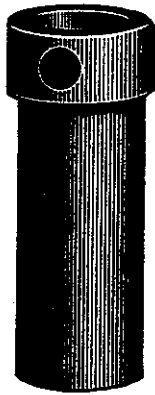

51244C



51290A



51254A

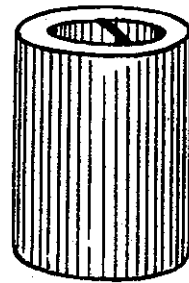

51290 E



51257D



51254



52889

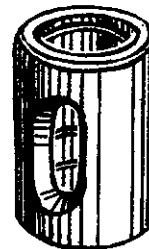

51244E

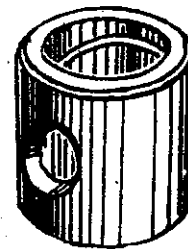

51290

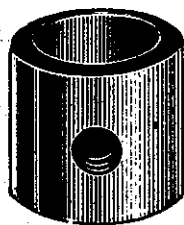

51142A

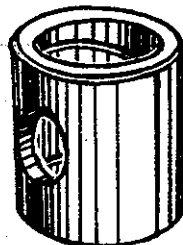

51290D

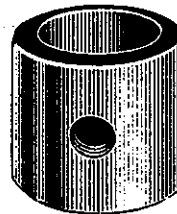

51142

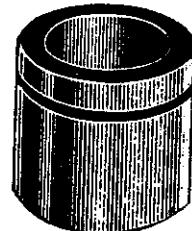

51250B

Plate 6 - Full Size

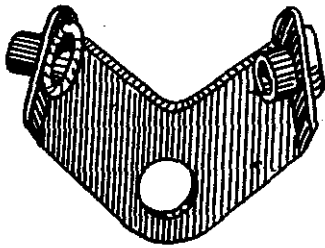

51192G

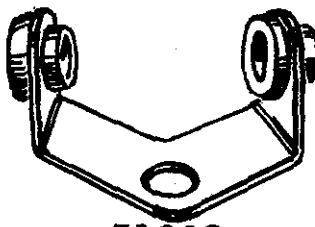

51092



51158D



51758

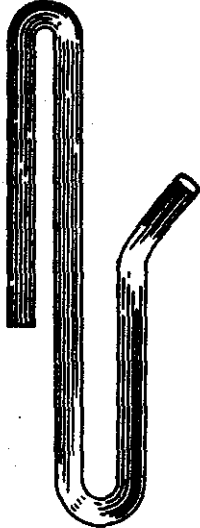

51170E



51070



52A

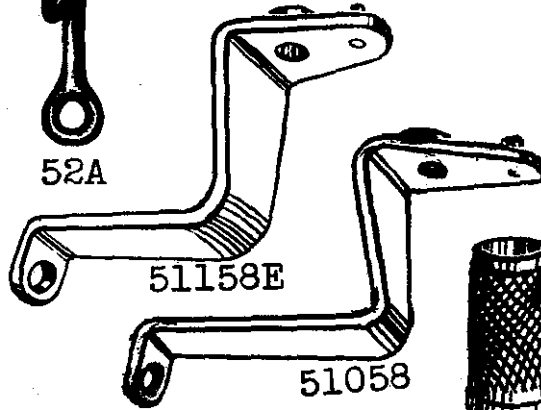

51158E

51058

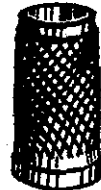

51240B

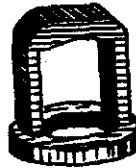

52887G



35731A

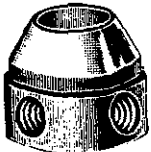

15465F

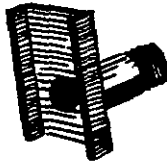

51134G



51243C

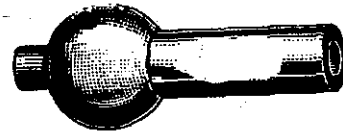

51243B

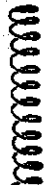

1286B



51186D

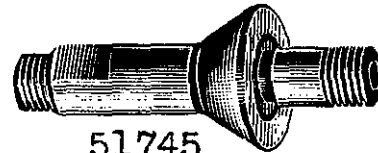

51745

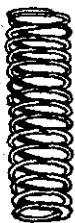

51292 F-1



51292F-2



51292F-8



51292F-14



51240C

Plate 7 - Full Size

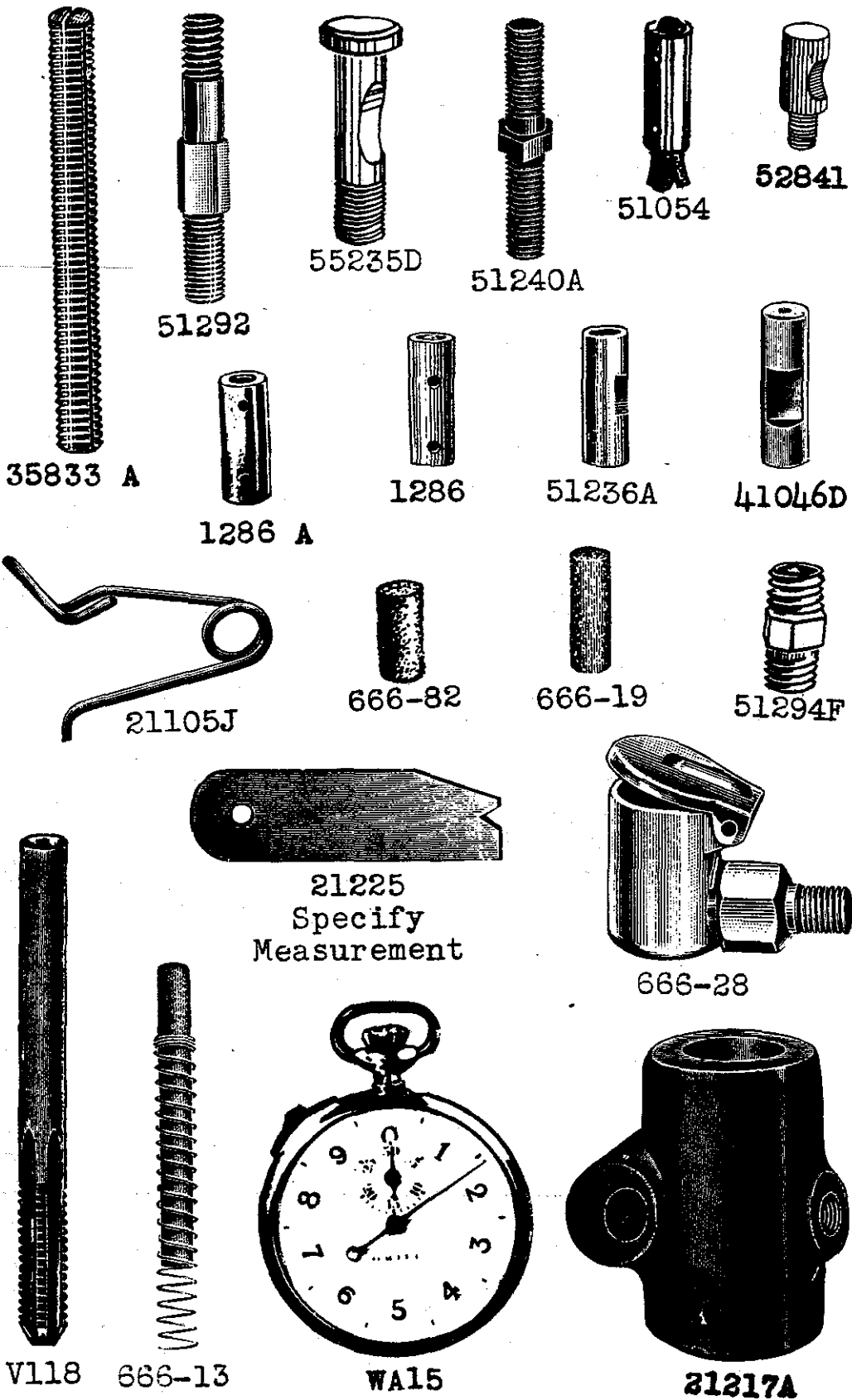
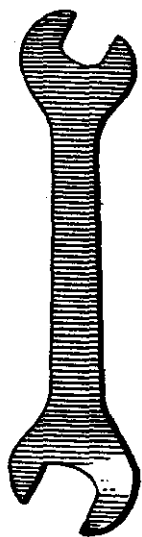
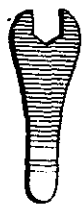



Plate 8 - One-half Size



21388R



116



21388

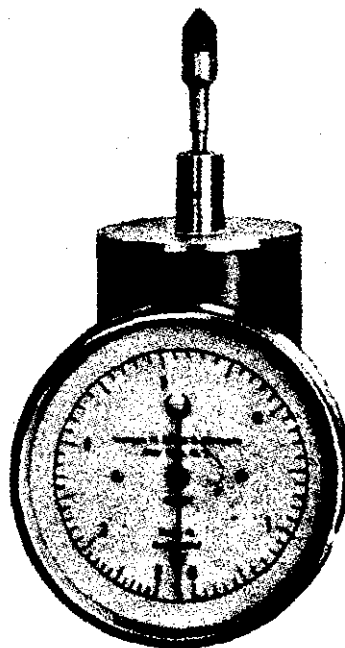

TA55A



21388N

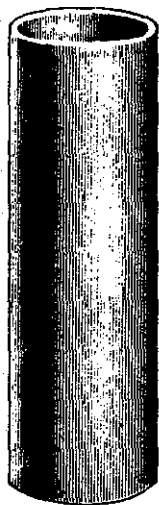

21355

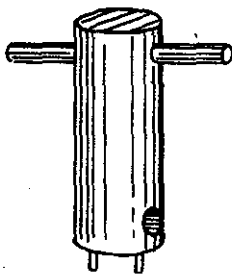

21388Z



21207



21104 E



21104 C

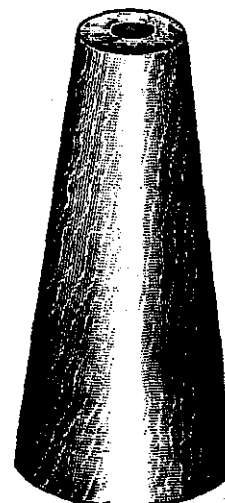

21145

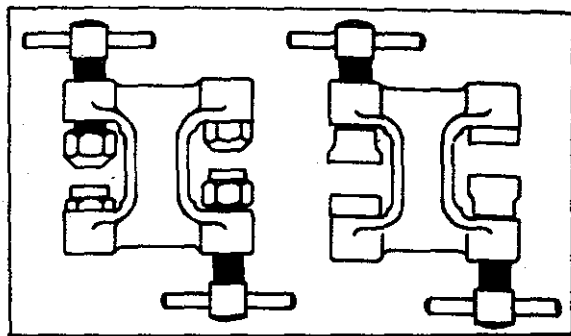

21227HK



51083



51183

Plate 9 - One-half Size

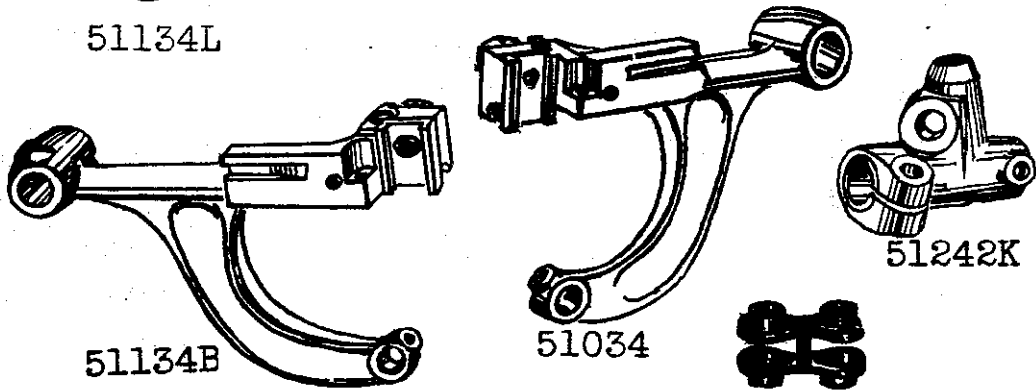
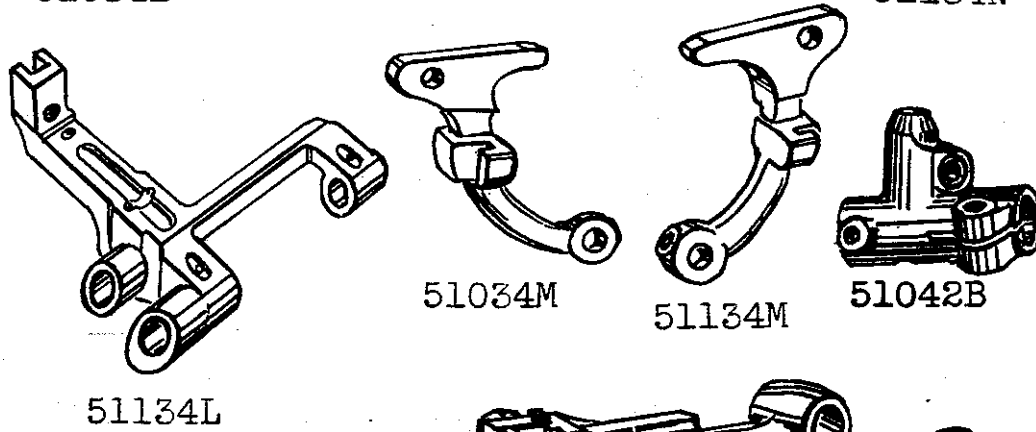
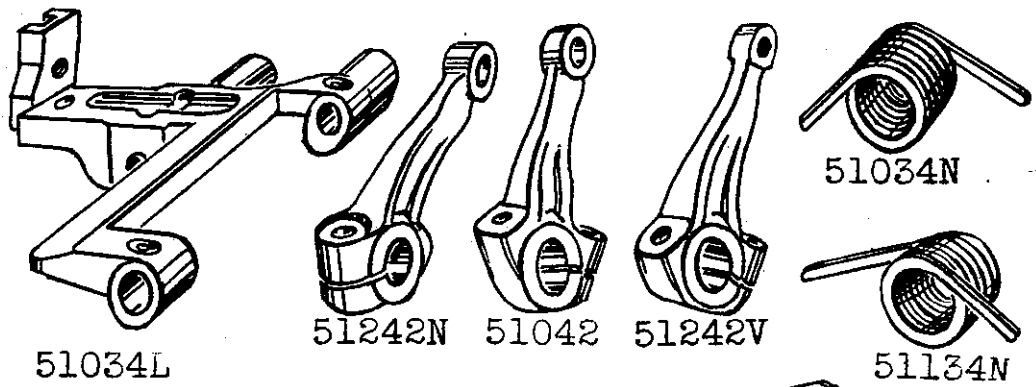

54

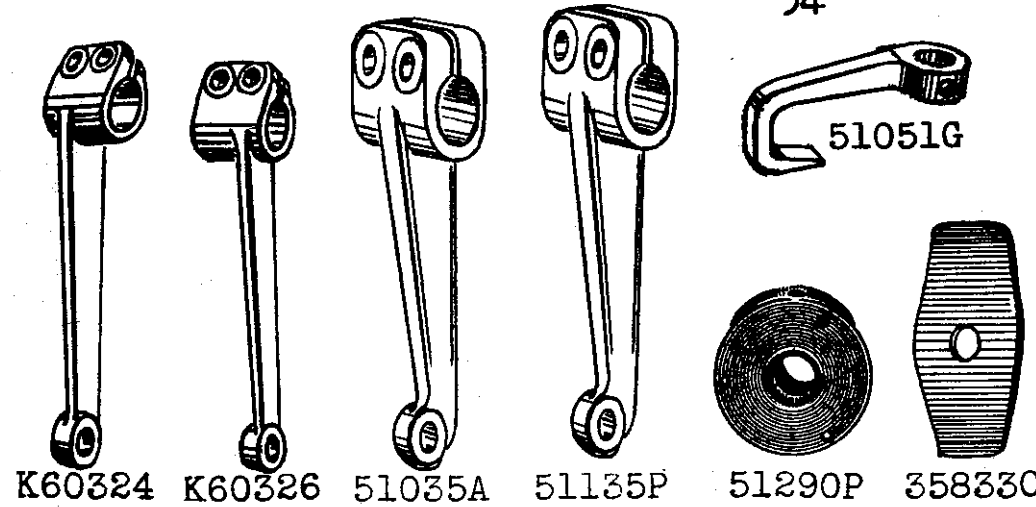

Plate 10 - One-half Size

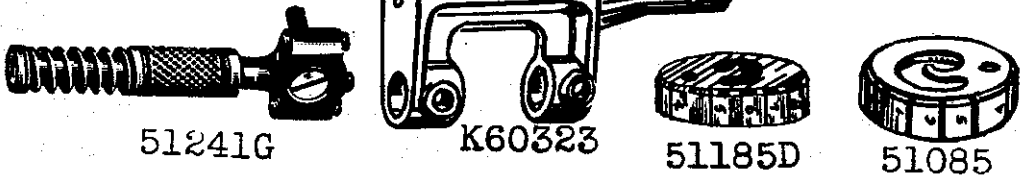
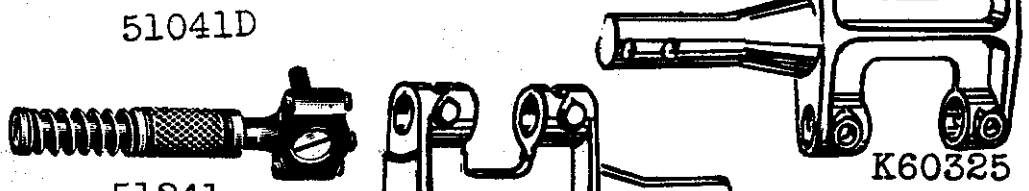
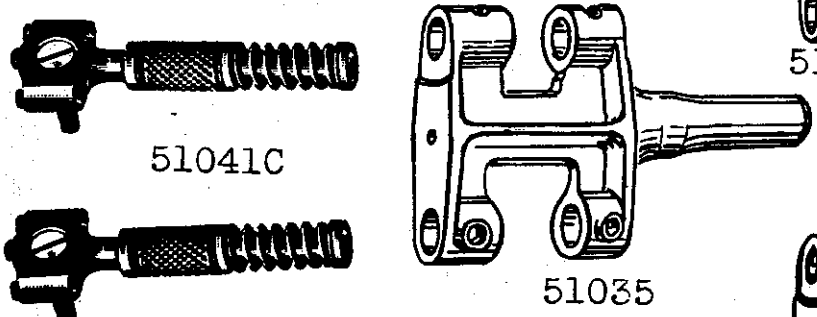
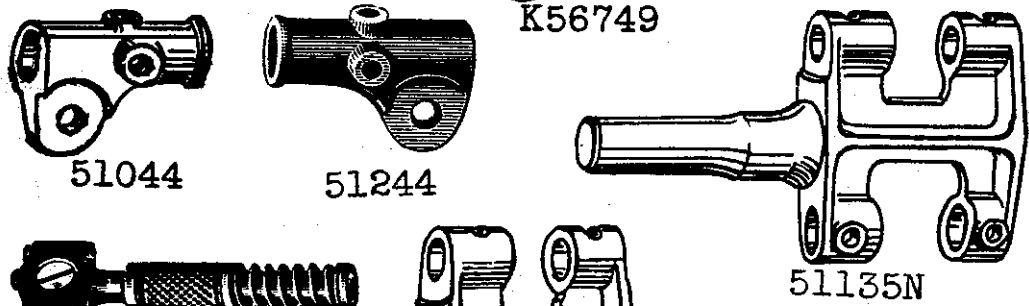
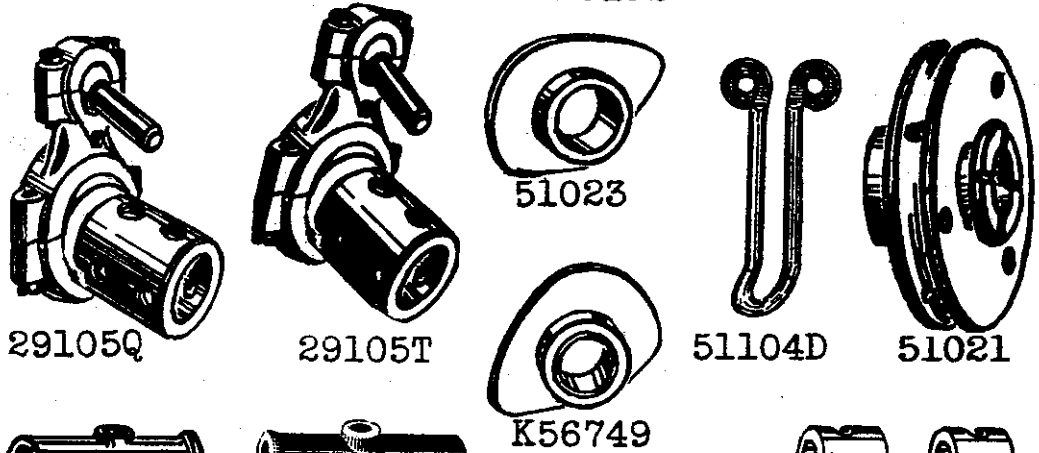
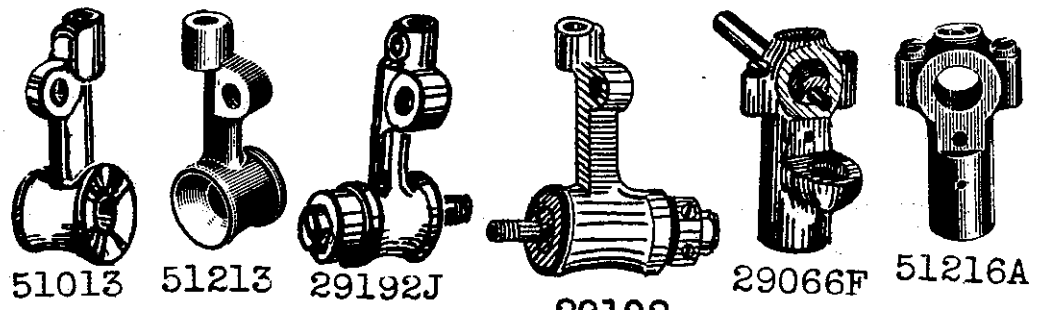
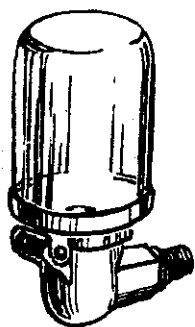
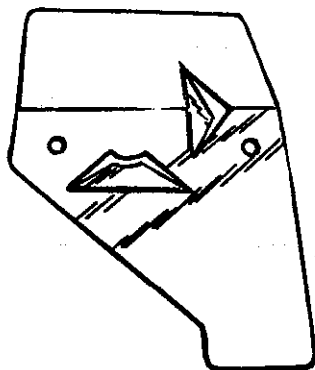

Plate 11 - One-half Size



666-77



51282N

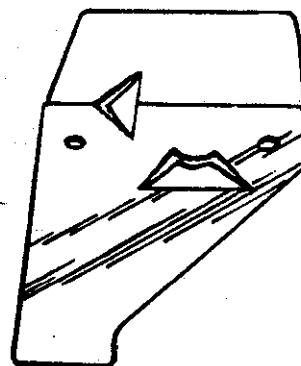

51082D

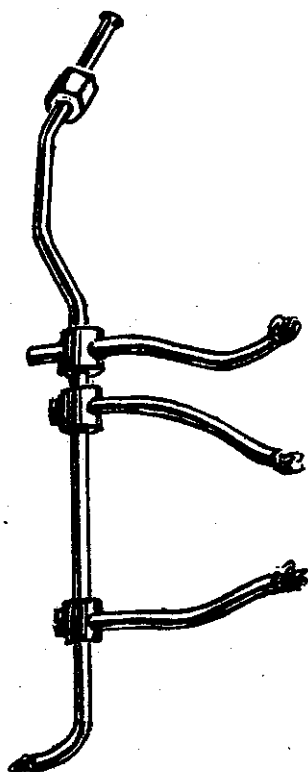

51093A

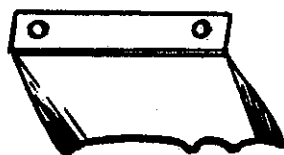

51082B

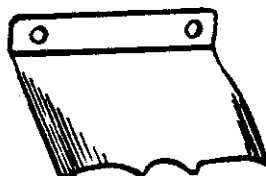

51282F

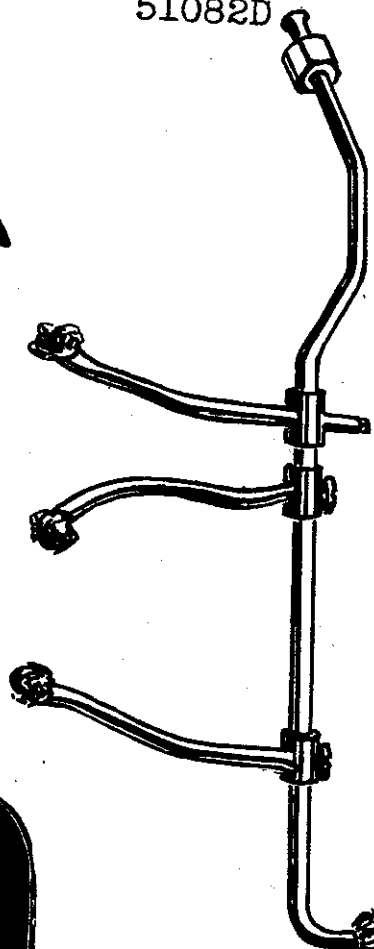

K59048

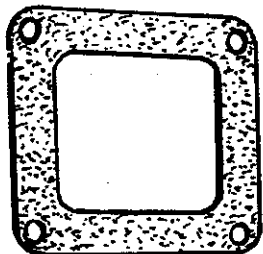

51282U

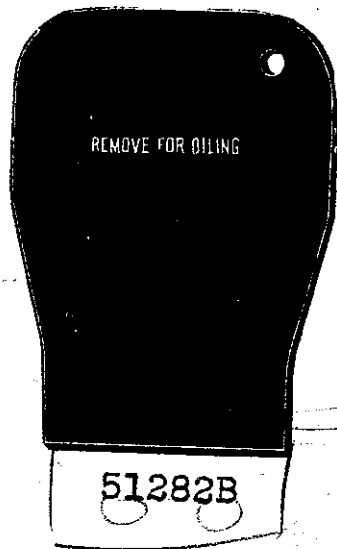

51282B

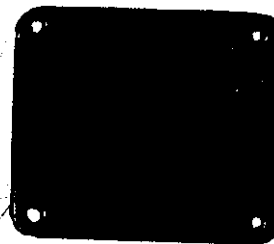

51282T

Plate 12 - One-half Size

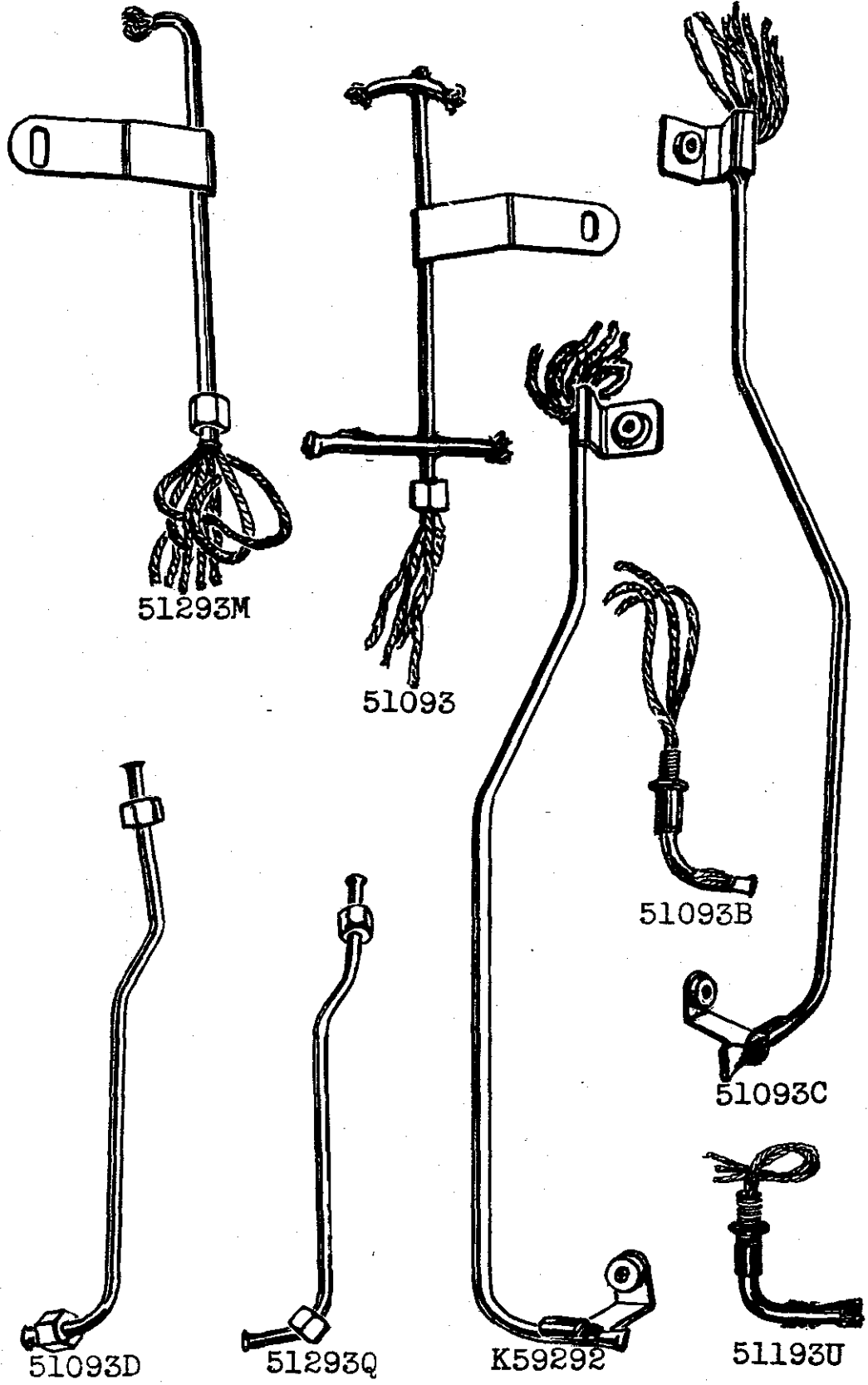

Plate 13 - One-half Size

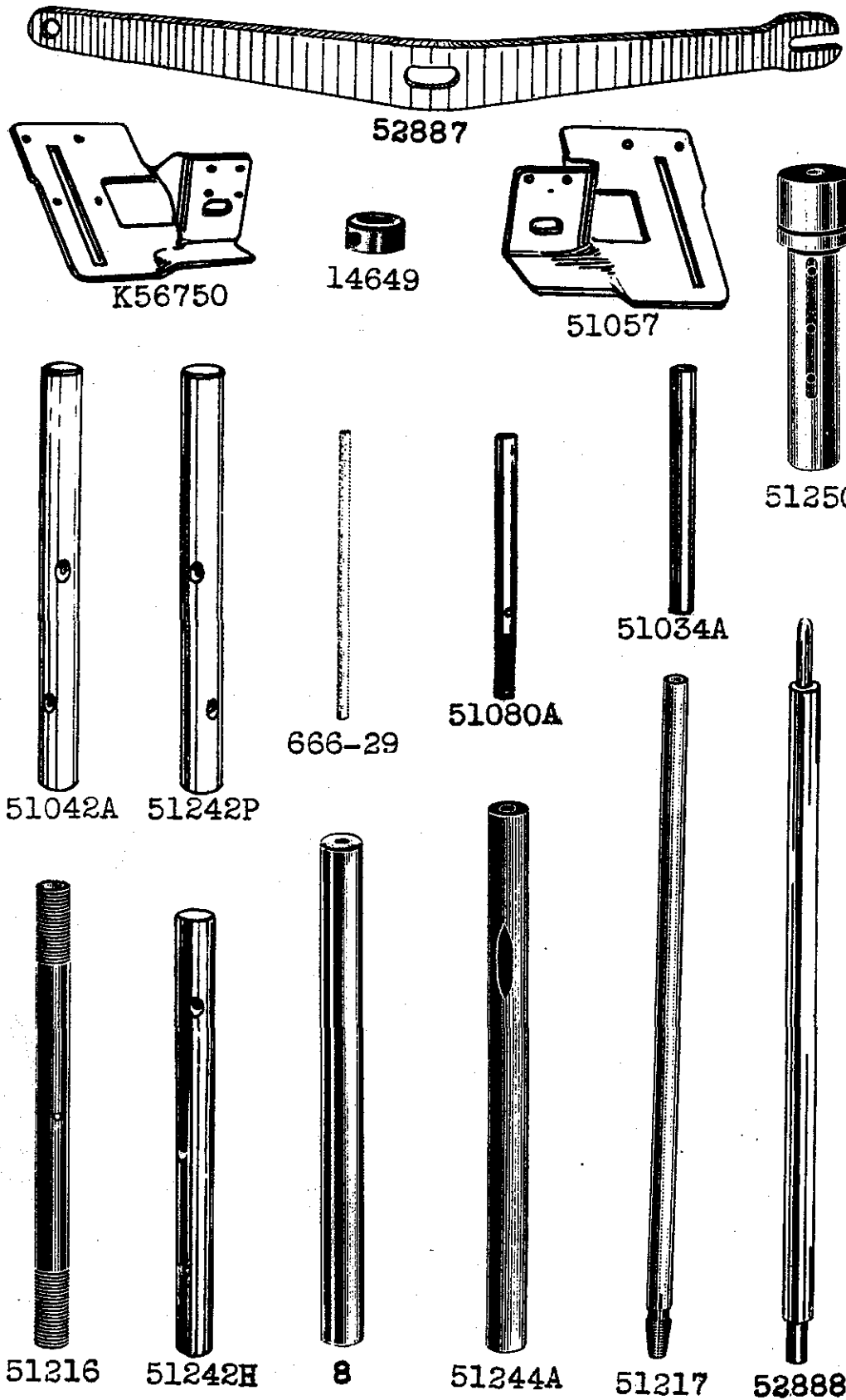

Plate 14 - One-fourth Size



29476AK



29476BX



51022



51722

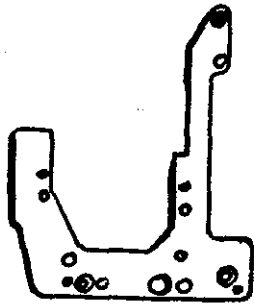

51080

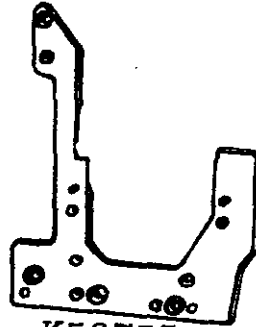

K56755



21104B  
Specify  
Length



51015



51115



29348E



29348D

Plate 15 - One-fourth Size

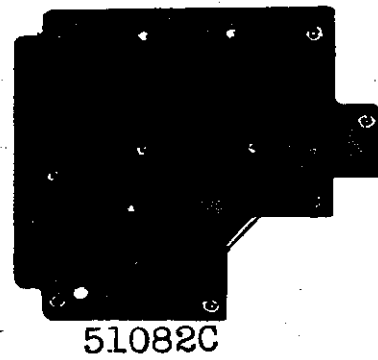
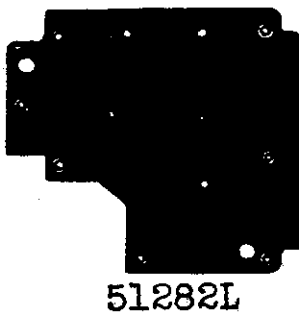
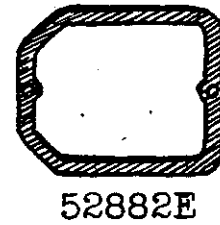
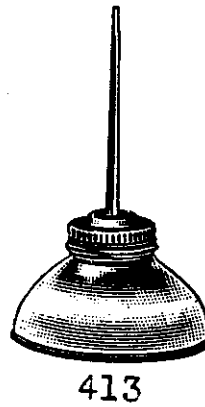
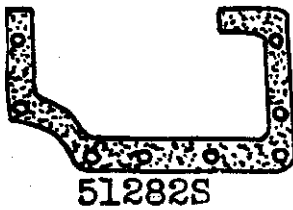
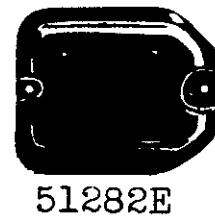
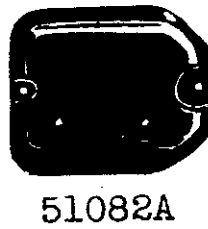
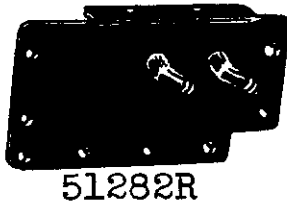
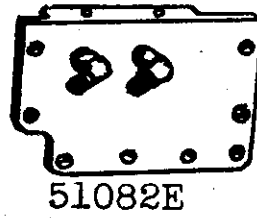
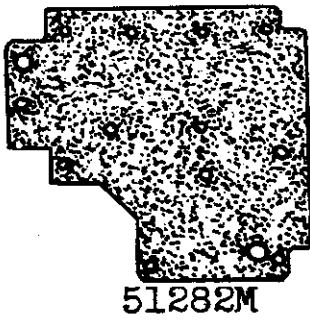



Plate 16 - One-fourth Size

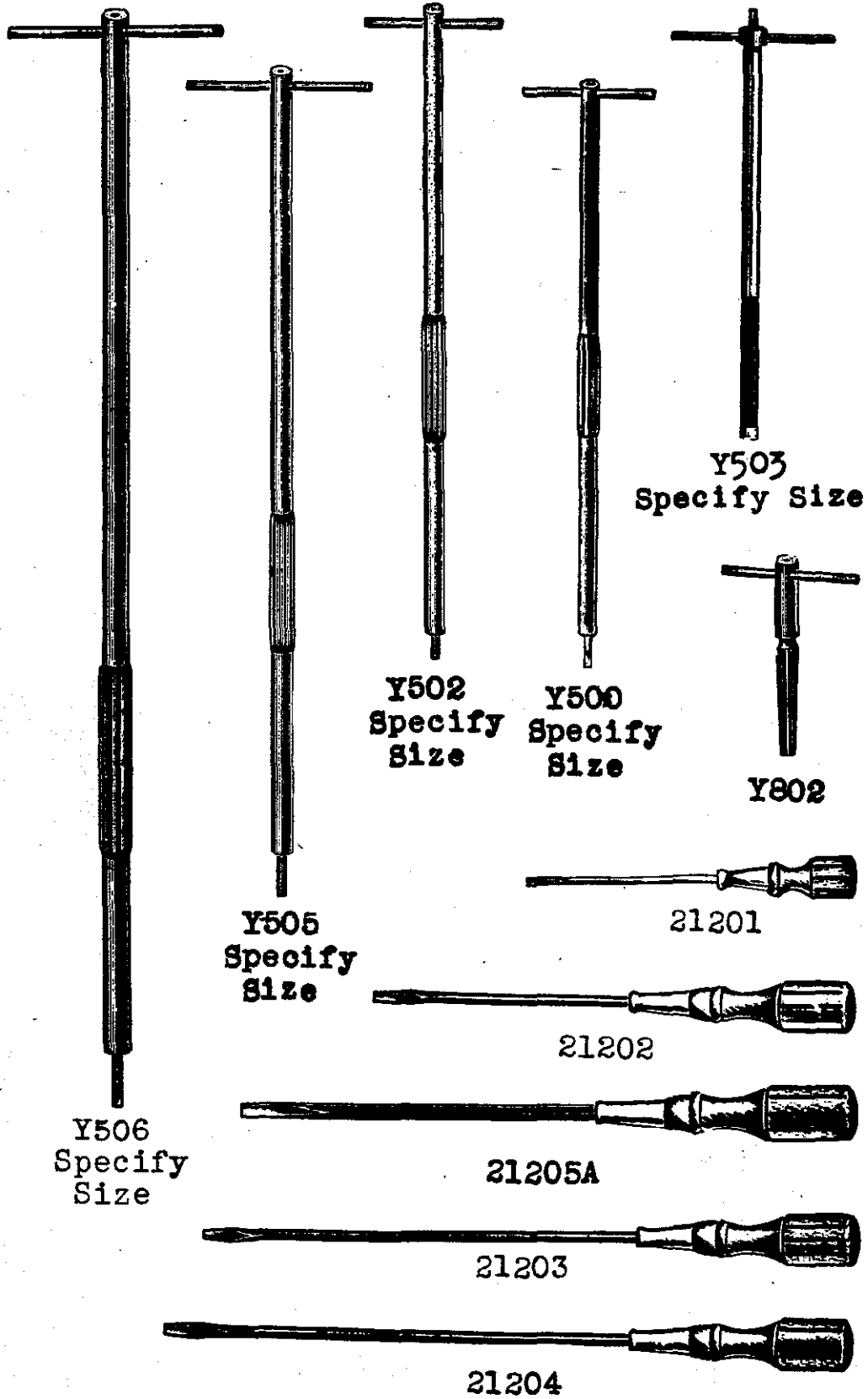

Plate 17 - One-eighth Size



21388F



21104D



21104G

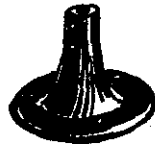

21114 A



21127



51001



K59837



21388X



21102B

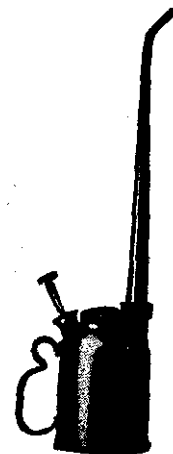

01-19

LIST OF PARTS

Symbol to Order By	The figures in the last column refer only to the plates illustrating the parts and are not to be used in ordering. Prices furnished on application.	Plate No.
8	Feed Rocker Shaft- - - - -	13
WA15	Stop Watch - - - - -	7
18	Looper Connecting Rod Nut, right thread; also for Nos. 51041, 51241 D- - - - -	4
OI-19	Pressure Pump Oil Can, 1 1/2 pints capacity- -	17
20	Feed Crank Stud Washer, left; also for Nos. 51070, 51170 E, 51758- - - - -	4
20 M	Feed Crank Stud Washer, right- - - - -	4
36 G	Washer, for looper connecting rod ball joint assemblies Nos. 51041 C, 51241 - - - - -	4
52 A	Frame Needle Thread Eyelet (screw No. 98 A)- -	6
54	Needle Lever Link- - - - -	9
TA54	Hand Tally - - - - -	-
TA55 A	Hand Tachometer, 2000 to 8000 R.P.M. - - - - -	8
56	Needle Clamp Nut - - - - -	4
73	Set Screw, for looper- - - - -	3
73 A	Screw, for looper needle guard - - - - -	3
74	" for attaching customer's gear to pulley; also for No. 51242 V- - - - -	4
75 A	" for lower needle lever connecting rod bearing - - - - -	4
77	Set Screw, for feed crank link pin; also for No. 51236 A - - - - -	3
78	" " for lower needle lever link pin - -	3
80	Screw, 33/64 inch long, for cloth plate- - - -	3
81	Spot Screw, for looper drive levers; also for Nos. 51042 B, 51242 K- - - - -	3
88	Screw, for looper rocker cone; also for No. 14649- - - - -	3
88 A	Set Screw, for needle bar- - - - -	3
88 B	Screw, for looper rocker shaft sleeve- - - - -	3
90	" for crankshaft chamber cover; also for No. 41046 D - - - - -	3
91	Clamp Screw, for presser foot- - - - -	3
93	" " for looper rock shaft arm; also for No. 21102 B - - - - -	3
95	Screw, for main shaft collar; also for No. 51051 G- - - - -	3
96	Spot Screw, for looper rocker frame; also for Nos. 29105 Q, 29105 T, 51023, 51142, 51142 A, K56749- - - - -	3
97	Screw, for needle lever ball stud fork; also for No. 51243 C- - - - -	3
97 A	Screw, for looper connecting rod ball joints; also for No. 51216 A - - - - -	3
98	Set Screw, for looper rocker frame; also for Nos. 29105 Q, 29105 T, 51035, 51135 N, K60323, K60325 - - - - -	3
98 A	Screw, for frame thread eyelets- - - - -	3
109 B	Tension Disc - - - - -	4
116	Wrench, 9/32 inch opening, for needle clamp nut- - - - -	8

LIST OF PARTS

Symbol to Order By	The figures in the last column refer only to the plates illustrating the parts and are not to be used in ordering. Prices furnished on application.	Plate No.
V118	Tap, marked "X-2", for plus size cloth plate screw No. 22521- - - - -	7
187 A	Screw, for crankshaft chamber cover oil drip plate, also for Nos. 51082 D, 51282 N- - - -	3
258 A	Looper Rocker Cone Nut; also for No. 35833 A	4
269	Looper Connecting Rod Nut, left thread; also for Nos. 51036, 51136 E- - - - -	4
402	Hand Lifter Stop Pin - - - - -	3
413	Oil Can, complete- - - - -	15
Y500-257	Expansion Reamer, for needle bar bearings, size .257 inch - - - - -	16
Y502-319	" " for upper presser bar bearing, size .319 inch- - - - -	16
Y503-319	" " for lower presser bar bearing, size .319 inch- - - - -	16
Y505-407	" " for looper rocker and feed rocker shaft bearings, size .407 inch- - - - -	16
Y506-530	" " for main shaft bearings, size .530 inch - - - - -	16
538	Screw, for supporting feed dog - - - - -	3
627	Clamp Screw, for looper drive lever rocker - -	3
650 A-16	Stove Bolt, flat head, 5/16 x 2 inches - - - -	4
650 A-18	" " flat head, 5/16 x 2 1/2 inches - - - -	4
652-16	Washer, 1/4 inch - - - - -	4
666-13	Felt Wick, spring pressed, for main shaft bearings- - - - -	7
666-19	" " for needle lever connecting rod bearing - - - - -	7
666-28	Oil Cup, for needle lever stud (nut No.12987A)	7
666-29	Felt Wick, for needle lever stud - - - - -	13
666-77	Constant Level Oiler - - - - -	11
666-82	Feed Lift Eccentric Oil Wick, also looper avoid eccentric oil wick - - - - -	7
668-1	Steel Insert, for tension thread eyelet- - - -	4
668-14	Steel Insert Ferrule, for tension thread eyelet - - - - -	4
719	Set Screw, for needle lever stud, also for No. 51250 B- - - - -	3
Y802	Taper Reamer, for needle lever link and feed crank pins - - - - -	16
906 A	Adjusting Screw, for upper feed dog (nut No. 907) - - - - -	4
907	Adjusting Screw Lock Nut, for upper feed - - -	4
1280	Tilting Feed Dog Holder Lock Nut - - - - -	4
1286	Feed Crank Link Pin Assembly; one each Nos. 1286 A, 1286 B, 12964 C, 22560 - - - - -	7
1286 A	Feed Crank Link Pin; also needle lever link pin (screw No. 77) - - - - -	7
1286 B	Feed Crank Link Pin Spring (screw No. 22560)	6
6042 A	Tilting Feed Dog Holder Washer, also for No. 55235 D- - - - -	4

LIST OF PARTS

Symbol to Order By	The figures in the last column refer only to the plates illustrating the parts and are not to be used in ordering. Prices furnished on application.	Plate No.
8372 A	Looper Drive Ball Joint Locking Stud Washer	4
12538	Looper Connecting Rod and Ball Joint Assembly Nut- - - - -	4
12964 C	Feed Crank Link Pin Ball - - - - -	4
12987 A	Nut, for needle lever stud oil cup; also for Nos. 51093 B, 51193 U- - - - -	4
14649	Feed Rocker Shaft Collar (screw No. 88)- - -	13
15430 C	Needle Lever Connecting Rod Nut, left thread	4
15430 D	" " " " " right thread	4
15465 F	Looper Rocker Cone (screw No. 88, nut No. 258 A) - - - - -	6
21102 B	Thread Stand Thread Guide Rod (screw No. 93)	17
21104 B-18	Thread Stand Vertical Rod, 18 inches long; also horizontal spool seat rod (screw No. 22509) - - - - -	14
21104 B-24	Thread Stand Vertical Rod, 24 inches long (screw No. 22591)- - - - -	14
21104 C	Thread Stand Rod Connection (screw No. 22509)	8
21104 D	Thread Stand Spool Seat- - - - -	17
21104 E	" " " " Connection - - - - -	8
21104 G	" " " Pin - - - - -	17
21105 J	" " Thread Guide- - - - -	7
21114 A	" " Base (screw No. 22591)- - - - -	17
21127	" " Vertical Rod Connection (screw No. 22580)- - - - -	17
21145	Cone, wood, for thread stand - - - - -	8
21201	Screw Driver, 9/64 inch round blade, length overall 7 5/8 inches - - - - -	16
21202	Screw Driver, 7/32 inch round blade, length overall, 11 1/4 inches - - - - -	16
21203	Screw Driver, 13/64 inch round blade, length overall 15 1/2 inches- - - - -	16
21204	Screw Driver, 9/32 inch round blade, length overall 15 inches- - - - -	16
21205 A	Screw Driver, 3/8 inch round blade, length overall 14 inches- - - - -	16
21207	Screw Driver, 7/64 inch round blade, length overall 2 1/2 inches - - - - -	8
21210	Looper Collar, .040 inch thick - - - - -	4
21217 A	Thread Stand Thread Guide Rod Support (screw No. 22591) - - - - -	7
21225-5/32	Looper Adjusting Gauge, 5/32 inch measure- ment - - - - -	7
21227 HK	Steel Insert Replacement Tool Set, for assembling insert No. 668-1 and ferrule No. 668-14 in tension thread eyelet. Ferrule should always be replaced- - - - -	8
21260	Emery Cord, 3/64 inch diameter, grade No. 120, fifty yard spool- - - - -	--
21260 A	Emery Cord, 3/64 inch diameter, grade No. 150, fifty yard spool- - - - -	--

LIST OF PARTS

Symbol to Order By	The figures in the last column refer only to the plates illustrating the parts and are not to be used in ordering. Prices furnished on application.	Plate No.
21260 B	Emery Cord, 1/32 inch diameter, grade No. 180, fifty yard spool- - - - -	---
21260 C	" " .025 inch diameter, grade No. 200, fifty yard spool- - - - -	---
21260 D	Emery Tape, 3/32 inch wide, grade No. 180, fifty yard spool- - - - -	---
21260 E	Emery Cord, .018 inch diameter, grade No. 200, fifty yard spool- - - - -	---
21355	Chair Leg Extension, 4 inches long- - - - -	8
21388	Wrench. single end, 3/8 inch opening- - - - -	8
21388 F	" offset, for adjusting the stitch length	17
21388 N	" double end, 3/16 and 5/16 inch openings	8
21388 R	" double end, 3/8 and 1/2 inch openings	8
21388 X	" for main shaft bearing housing- - - - -	17
21388 Z	Wrench, for setting needle lever stud correctly with respect to oil groove. Stud is set correctly when the pin hole nearest the periphery is up and a line drawn between the two pin holes is 45 degrees to the right of the vertical- - - - -	8
21394	Utility Grinder, including emery wheel, 5 inches diameter, 1/4 inch face, round belt drive, recommended speed 3000 R.P.M.- - - - -	---
21394 G	Emery Wheel, 5 inches diameter, 1/4 inch face, 3/8 inch hole, grade "M" emery 60	---
21394 H	" " 5 inches diameter, 1/2 inch face, 3/8 inch hole, grade "M" emery 60	---
21394 K	Utility Grinder, including emery wheel, 5 inches diameter, 1/2 inch face, round belt drive, recommended speed 3000 R.P.M.- - - - -	---
21657 E	Cast-off Wire Support Washer- - - - -	4
22509	Set Screw, square head, cup point, 5/16 inch diameter, 18 threads per inch, 1/2 inch long, for thread stand rod connection - - - - -	4
22513	Screw, for presser bar connection guide plate	3
22519 C	Clamp Screw, for feed rocker arm- - - - -	3
22521	Screw, plus size, for cloth plate (tap No.V118)	3
22524	" countersunk head, for oil reservoir top cover- - - - -	3
22528	" for cast-off wire support; also for Nos. K42774, 51005 A, 51026 A, 51243 B, K58615	3
22539 A	Plug Screw, for looper drive lever shaft hole	3
22559 A	Bearing Screw, lower, for looper drive connec- tion - - - - -	3
22559 B	" " upper, for looper drive connec- tion - - - - -	4
22560	Screw, for feed crank link pin spring - - - - -	3
22560 B	" for presser bar guide; also for Nos. 51034, 51134 B - - - - -	3
22561	" for stitch regulator indicator - - - - -	3
22569 B	" for main shaft bushing housing - - - - -	3
22570	" fillister head, for throat plates- - - - -	3

LIST OF PARTS

Symbol to Order By	The figures in the last column refer only to the plates illustrating the parts and are not to be used in ordering. Prices furnished on application.	Plate No.
22571 A	Plug Screw, for spring pressed felt wicks on main shaft bearings; also for oil drain hole in main oil reservoir- - - - -	3
22580	Set Screw, for looper thread take-up; also for No. 21127 - - - - -	3
22585 A	Screw, fillister head, for oil reservoir top cover - - - - -	3
22585 B	Screw, for needle rear guard- - - - -	3
22591	Set Screw, for thread stand rods; also for No. 21217 A - - - - -	3
22593	Screw, for looper thread cast-off guide wire; also for No. 51158 D- - - - -	3
22595	Screw, for needle lever link pin oil tube - - - - -	3
22597	Spot Screw, for pulley- - - - -	3
22597 A	Set Screw, for pulley - - - - -	3
22733 A	Plug Screw, for hole in top of bed on Style 51100 N - - - - -	3
22747	Screw, for needle lever thread eyelet - - - - -	3
22799 F	Locating Screw, for stitch regulator index washer- - - - -	3
22801	Pivot Screw, for needle rear guard- - - - -	3
22829	Locking Screw, for looper rocker cone nut; also for Nos. 51093, 51293 M- - - - -	3
22834	Screw, for regulating needle rear guards- - - - -	3
22837	Thumbscrew, for face plate- - - - -	3
22839	Screw, fillister head, for throat plate supports- - - - -	3
22840	Adapter Screw, for frame thread eyelet- - - - -	3
22848	Screw, for oil reservoir back cover; also for No. 51070, 51170 E, 51758 - - - - -	3
22849	Screw, right, for upper crank chamber cover; also for Nos. 51093 C, K59292 - - - - -	3
22850	Stud, for hand lifter - - - - -	4
22863	Adjusting Screw, for feed dog holder- - - - -	3
22864	Needle Lever Link Pin Clamp Screw (nut No. 51250 C)- - - - -	4
22872	Plug Screw, for lower tension post hole on Style 51100 N - - - - -	3
22882 A	Clamp Screw, for looper drive levers Nos. 51042, 51242 N- - - - -	4
28604 G	Straight Mineral Oil, S.A.E. 10 "W" put up in 10 fluid ounces to can, which is the capacity of machine - - - - -	--
28606-1/2	Powdered Oil Stone, 1/2 lb. package - - - - -	--
28606-1	" " " 1 lb. package - - - - -	--
29066 F	Needle Lever Connecting Rod Upper Bearing Assembly; one each Nos. 51216 A, 51243 B- - - - -	10
*29105 Q	Looper Drive Eccentric Assembly, includes eccentric No. 51343, for Style 51100 N (set screw No. 98, spot screw No. 96, bearing screw, upper, No. 22559 B, bearing screw, lower, No. 22559 A) - - - - -	10

\*See Page 5

LIST OF PARTS

Symbol to Order By	The figures in the last column refer only to the plates illustrating the parts and are not to be used in ordering. Prices furnished on application.	Plate No.
*29105 T	Looper Drive Eccentric Assembly, includes eccentric No. 51043, for Style 51000 A (set screw No. 98, spot screw No. 96, bearing screw, upper, No. 22559 B, bearing screw, lower, No. 22559 A) - - - - -	10
29192	Looper Rocker Assembly, for Style 51100 N; one each Nos. 51213, 15465 F, 51745 lapped to- gether, Nos. 258 A, 22829; two No. 88 - - - - -	10
29192 J	Looper Rocker Assembly, for Style 51000 A; one each Nos. 51013, 15465 F, 51745 lapped to- gether, Nos. 258 A, 22829; two No. 88 - - - - -	10
29348 D	Needle Lever Assembly, for Style 51100 N; one each Nos. 51215 C, 51250 lapped together, Nos. 54, 78, 22864, 35759, 51250 C; two each Nos. 88 A, 1286, 22528- - - - -	14
29348 E	Needle Lever Assembly, for Style 51000 A; one each Nos. 51015, 51250 lapped together, Nos. 54, 78, 22864, 35759, 51250 C; two each Nos. 88 A, 22528, 51054- - - - -	14
*29476 AK	Crankshaft Assembly, for Style 51100 N; in- cludes crankshaft No. 51322 A (bearing screw No. 75 A) - - - - -	14
*29476 BX	Crankshaft Assembly, for Style 51000 A, in- cludes crankshaft No. 51022 A (bearing screw No. 75 A) - - - - -	14
35731 A	Presser Bar Connection Guide Plate (screw No. 22513)- - - - -	6
35733 B	Presser Spring Regulating Screw Lock Nut- - - - -	4
35759	Needle Bar Connection (needle bar set screw No. 88 A, link pin set screw No. 78)- - - - -	2
35768 A	Screw, left, for upper crank chamber cover- - - - -	3
35833 A	Presser Spring Regulating Stud (nut No. 258 A)	7
35833 C	Presser Spring Plate- - - - -	9
39236 A	Needle Rear Guard Washer- - - - -	4
41046 D	Upper Feed Bar Arm Pin (screw No. 90) - - - - -	7
K42774	Upper Feed Dog, for Style 51100 N (attaching screw No. 22528, adjusting screw No. 906 A, adjusting screw nut No. 907)- - - - -	1
K43502	Presser Foot, for Style 51100 N (clamp screw No. 91) - - - - -	1
51001	Cloth Plate, for Style 51000 A (screw No. 80)	17
51005 A	Feed Dog, lower, for Style 51000 A (screw No. 22528)- - - - -	1
51008 A	Looper, for Style 51000 A (screw No. 73)- - - - -	2
51010 A	Looper Needle Guard, for Style 51000 A (screw No. 73 A) - - - - -	2
51013	Looper Rocker, for Style 51000 A- - - - -	10
*51015	Needle Lever, includes bushing, for Style 51000 A - - - - -	14
51020 A	Presser Foot, for Style 51000 A (clamp screw No. 91) - - - - -	1



LIST OF PARTS

Symbol to Order By	The figures in the last column refer only to the plates illustrating the parts and are not to be used in ordering. Prices furnished on application.	Plate No.
51021	Pulley (spot screw No. 22597, set screw No. 22597 A, gear attaching screw No. 74) - - - -	10
51022	Main Shaft, right section, for Style 51000 A	14
51023	Looper Thread Take-up, for Style 51000 A (spot screw No. 96, set screw No. 22580) - - - -	10
51024 A	Throat Plate, for Style 51000 A (screw No. 22570) - - - - -	1
51025 A	Needle Rear Guard, for Style 51000 A (screw No. 22585 B, washer No. 39236 A) - - - - -	2
51026 A	Upper Feed Dog, for Style 51000 A (attaching screw No. 22528, adjusting screw No. 906 A, adjusting screw nut No. 907) - - - - -	1
*51034	Feed Bar, lower, including tiltable feed dog holder, for Style 51000 A (set screw No. 22560 B, feed dog supporting screw No. 538, feed dog holder No. 51134 G, holder adjusting screw No. 22863, holder nut No. 1280, holder washer No. 6042 A) - - - - -	9
51034 A	Feed Bar Shaft - - - - -	13
51034 L	Feed Bar, upper, for Style 51000 A - - - - -	9
51034 M	Upper Feed Bar Arm, for Style 51000 A (pin No. 41046 D, pin screw No. 90) - - - - -	9
51034 N	Upper Feed Bar Spring, for Style 51000 A - - - -	9
51035	Feed Rocker, .562 inch diameter stem, for Style 51000 A (screw No. 98) - - - - -	10
51035 A	Feed Rocker Arm, .561 inch diameter hole, for Style 51000 A (locking stud No. 55235 D, locking stud washer No. 6042 A, locking stud nut No. 55235 E) - - - - -	9
51036	Feed Crank Stud (nut No. 269) - - - - -	2
*51041	Looper Connecting Rod Ball Joint Assembly, right, for Style 51000 A equipped with looper drive lever No. 51242 V (bearing screw No. 97 A, nut No. 18) - - - - -	2
*51041 C	Looper Connecting Rod, jointed section and ball joint assembly, for Style 51000 A equipped with looper drive lever No. 51242 V (ball stud washer No. 36 G, bearing screw No. 97 A, jointed section sleeve No. 51240B, sleeve spring No. 51240 C) - - - - -	10
*51041 D	Looper Connecting Rod, jointed section and ball joint assembly, with .232 inch diameter shoulder on ball stud, for Style 51000 A equipped with looper drive lever No. 51042 (ball stud washer No. 51741 E, bearing screw No. 97 A, jointed section sleeve No. 51240B, sleeve spring No. 51240 C) - - - - -	10
*51041 E	Looper Connecting Rod Ball Joint Assembly, right, for Style 51000 A equipped with looper drive lever No. 51042 (bearing screw No. 97 A, nut No. 18) - - - - -	2

LIST OF PARTS

Symbol to Order By	The figures in the last column refer only to the plates illustrating the parts and are not to be used in ordering. Prices furnished on application.	Plate No.
51042	Looper Drive Lever, steel, with .232 inch diameter reamed hole for ball stud, clamping lug on right, for Style 51000 A (spot screw No. 81, clamp screw No. 22882 A) - - - - -	9
51042 A	Looper Drive Lever Shaft, for Style 51000 A equipped with looper drive lever No. 51042 - -	13
51042 B	Looper Drive Lever Rocker (spot screw No. 81, clamp screw No. 627) - - - - -	9
51044	Looper Rocker Frame, for Style 51000 A (spot screw No. 96, set screw No. 98) - - - - -	10
51051	Presser Bar Guide, for Style 51000 A (screw No. 22560 B) - - - - -	2
51051 G	Upper Feed Dog Lifter (screw No. 95) - - - - -	9
51054	Needle Lever Link Pin (clamp screw for upper link pin No. 22864, clamp screw nut No. 51250C, set screw for lower link pin No. 78) - - - - -	7
51057	Cast-off Wire Support, for Style 51000 A (screw No. 22528, washer No. 21657 E) - - - - -	13
51058	Needle Lever Thread Eyelet, for Style 51000 A (screw No. 22747) - - - - -	6
51070	Frame Needle Thread Guide Wire, for Style 51000 A (screw No. 22848, washer No. 20) - - -	6
51080	Throat Plate Support, for Style 51000 A (screw No. 22839) - - - - -	14
51080 A	Throat Plate Support Pin - - - - -	13
51082 A	Crankshaft Chamber Cover, upper, for Style 51000 A (attaching screw, right, No. 22849, attaching screw, left, No. 35768 A, gasket No. 52882 E) - - - - -	15
51082 B	Crankshaft Chamber Cover Oil Drip Plate, for Style 51000 A (screw No. 187 A) - - - - -	11
51082 C	Oil Reservoir Top Cover, for Style 51000 A (screw, countersunk head, No. 22524, screw, fillister head, No. 22585 A, gasket No. 51282 M	15
51082 D	Oil Reservoir Top Cover Oil Drip Plate, for Style 51000 A (screw No. 187 A) - - - - -	11
51082 E	Oil Reservoir Back Cover, for Style 51000 A (screw No. 22848) - - - - -	15
51083	Hand Lifter, for Style 51000 A (stud No. 22850)	8
51085	Stitch Regulator Index, for Style 51000 A - - - -	10
51092	Tension Thread Eyelet (insert No. 668-1, insert ferrule No. 668-14) - - - - -	6
51093	Looper Rocker Stud Oil Tube (screw No. 22829, coupling No. 61294 X) - - - - -	12
51093 A	Feed Rocker Oil Tube, also feed lift and looper avoid eccentric oil tube, for Style 51000 A (coupling No. 61294 X) - - - - -	11
51093 B	Feed Crank Link Oil Tube, for Style 51000 A (nut No. 12987 A) - - - - -	12
51093 C	Needle Lever Link Pin Oil Tube, for Style 51000 A (screw, left, No. 22595, screw, right, No. 22849) - - - - -	12

LIST OF PARTS

Symbol to Order By	The figures in the last column refer only to the plates illustrating the parts and are not to be used in ordering. Prices furnished on application.	Plate No.
51093 D	Right Main Shaft Bearing Oil Tube (coupling No. 61294 X)- - - - -	12
51104 D	Looper Thread Cast-off Guide Wire (screw No. 22593)- - - - -	10
51108 D	Looper, for Style 51100 N (set screw No. 73)-	2
51110 D	Looper Needle Guard, for Style 51100 N (screw No. 73 A) - - - - -	2
*51115	Needle Lever, includes bushing, for Style 51100 N - - - - -	14
*51134 B	Feed Bar, including tiltable feed dog holder, for Style 51100 N (set screw No. 22560 B, feed dog supporting screw No. 538, feed dog holder No. 51134 G, holder adjusting screw No. 22863, holder nut No. 1280, holder washer No. 6042 A) - - - - -	9
51134 G	Feed Dog Holder, tiltable (nut No. 1280, washer No. 6042 A) - - - - -	6
51134 L	Feed Bar, upper, for Style 51100 N- - - - -	9
51134 M	Upper Feed Bar Arm, for Style 51100 N (pin No. 41046 D, pin screw No. 90)- - - - -	9
51134 N	Upper Feed Bar Spring, for Style 51100 N- - - - -	9
51135 N	Feed Rocker, .562 inch diameter stem, for Style 51100 N (screw No. 98)- - - - -	10
51135 P	Feed Rocker Arm, .562 inch hole, for Style 51100 N (locking stud No. 55235 D, locking stud washer No. 6042 A, locking stud nut No. 55235 E)- - - - -	9
51136	Stitch Regulator Index Washer (locating screw No. 22799 F)- - - - -	4
51136 E	Feed Crank Stud, for Style 51100 N (nut No. 269)	2
51142	Looper Avoid Eccentric (spot screw No. 96)- - -	5
51142 A	Feed Lift Eccentric (spot screw No. 96) - - -	5
51145	Looper Avoid Eccentric Link, also feed lift eccentric link- - - - -	2
51147	Main Shaft Collar (screw No. 95)- - - - -	4
51158 D	Looper Thread Take-up Eyelet (screw No. 22593)	6
51158 E	Needle Lever Thread Eyelet (screw No. 22747)-	6
51170 E	Frame Needle Thread Guide Wire, for Style 51100 N (screw No. 22848, washer No. 20)- - -	6
51183	Hand Lifter, for Style 51100 N (stud No. 22850)	8
51185 D	Stitch Regulator Index, for Style 51100 N - - -	10
51186 D	" " Indicator (screw No. 22561)- - -	6
51190 D	Main Shaft Bearing Housing Gasket - - - - -	15
51192 B	Tension Post Ferrule- - - - -	4
51192 G	Tension Thread Eyelet (steel insert No. 668-1, insert ferrule No. 668-14)- - - - -	6
51193 U	Feed Crank Link Oil Tube, for Style 51100 N (nut No. 12987 A) - - - - -	12
51213	Looper Rocker, for Style 51100 N- - - - -	10
51216	Needle Lever Connecting Rod Tube (nut, left thread, No. 15430 C, nut, right thread, No. 15430 D)- - - - -	13

\*See Page 5

LIST OF PARTS

Symbol to Order By	The figures in the last column refer only to the plates illustrating the parts and are not to be used in ordering. Prices furnished on application.	Plate No.
51216 A	Needle Lever Connecting Rod Bearing, upper (screw No. 97 A) - - - - -	10
51217	Needle Bar (set screw No. 88 A) - - - - -	13
51225	Needle Rear Guard, for Style 51100 N (screw No. 22585 B, washer No. 39236 A) - - - - -	2
51235 G	Feed Rocker Arm Clamp Screw Washer - - - - -	4
51236 A	Feed Lift Eccentric Link Pin and Looper Avoid Eccentric Link Pin (screw No. 77)	7
*51236 E	Feed Crank Link Assembly - - - - -	2
51236 F	Feed Crank Link Ferrule - - - - -	5
51240 A	Looper Connecting Rod, adjusting section (nut, right thread, No. 18, nut, left thread, No. 269) - - - - -	7
51240 B	Looper Connecting Rod Jointed Section Sleeve - - - - -	6
51240 C	Looper Connecting Rod Jointed Section Sleeve Spring - - - - -	6
*51241	Looper Connecting Rod, jointed section, and ball joint assembly, right, for Style 51100 N equipped with looper drive lever No. 51242 V (ball stud washer No. 36 G, bearing screw No. 97 A, jointed section sleeve No. 51240 B, sleeve spring No. 51240 C) - - - - -	10
*51241 D	Looper Connecting Rod Ball Joint Assembly, left, for Style 51100 N equipped with looper drive lever No. 51242 V (bearing screw No. 97 A, nut No. 18) - - - - -	2
*51241 G	Looper Connecting Rod, jointed section, and ball joint assembly, with .232 inch diam- eter shoulder on ball stud, for Style 51100 N equipped with looper drive lever No. 51242 N (ball stud washer No. 51241E, bearing screw No. 97 A, jointed section sleeve No. 51240 B, sleeve spring No. 51240 C) - - - - -	10
51242 H	Looper Drive Lever Shaft, for machines equipped with looper drive lever No. 51242 V - - - - -	13
51242 K	Looper Drive Lever Rocker, for Style 51100 N (spot screw No. 81, clamp screw No. 627) - - - - -	9
51242 L-595	Looper Drive Lever Rocker Thrust Washer, .0595 inch thick - - - - -	4
51242 L-600	Looper Drive Lever Rocker Thrust Washer, .0600 inch thick - - - - -	4
51242 L-605	Looper Drive Lever Rocker Thrust Washer, .0605 inch thick - - - - -	4
51242 L-610	Looper Drive Lever Rocker Thrust Washer, .0610 inch thick - - - - -	4
51242 L-615	Looper Drive Lever Rocker Thrust Washer, .0615 inch thick - - - - -	4

\*See Page 5

LIST OF PARTS

Symbol to Order By	The figures in the last column refer only to the plates illustrating the parts and are not to be used in ordering. Prices furnished on application.	Plate No.
51242 L-620	Looper Drive Lever Rocker Thrust Washer, .620 inch thick - - - - -	4
51242 M	Looper Drive Lever Clamp Screw Washer - - -	4
51242 N	Looper Drive Lever, steel, with .232 inch diameter reamed hole for ball stud, clamping lug on left, for Style 51100 N (spot screw No. 81, clamping screw No. 22882 A)- - - - -	9
51242 P	Looper Drive Lever Shaft, for Style 51100 N equipped with looper drive lever No. 51242 N - - - - -	13
51242 Q	Looper Drive Lever Shaft Bushing, front - -	5
51242 R	" " " " " middle- -	5
51242 S	" " " " " rear- -	5
51242 V	Looper Drive Lever, steel, with threaded hole for ball stud, clamping lug on right (clamp screw No. 74, spot screw No. 81)	9
51243 B	Looper Drive Lever Ball Stud, also for Nos. 51015, 51115 (clamp screw No. 22528)- - -	6
51243 C	Looper Drive Lever Ball Stud Guide Fork, also for No. 51216 A (screw No. 97) - - -	6
51244	Looper Rocker Frame, for Style 51100 N (spot screw No. 96, set screw No. 98) - -	10
51244 A	Looper Rock Shaft - - - - -	13
51244 B	" " " Arm (clamp screw No. 93)	2
51244 C	" " " Sleeve- - - - -	5
51244 E	" " " Bushing, also feed rocker shaft bushing - - - - -	5
51246	" Rocker Stud Nut- - - - -	4
51250	Needle Lever Stud (screw No. 719) - - - - -	13
51250 A	" " " Bushing - - - - -	5
51250 B	" " Thrust Collar (screw No. 719)	5
51250 C	" " Link Pin Clamp Screw Nut - - -	4
51254	" Bar Bushing, upper - - - - -	5
51254 A	" " " lower - - - - -	5
51257 D	Presser Bar Bushing, lower- - - - -	5
51282 B	Face Plate (thumbscrew No. 22837) - - - - -	11
51282 E	Crankshaft Chamber Cover, upper, for Style 51100 N (attaching screw, right, No. 22849, attaching screw, left, No. 35768A)	15
51282 F	Crankshaft Chamber Cover Oil Drip Plate, for Style 51100 N (screw No. 187 A) - - -	11
51282 L	Oil Reservoir Top Cover, for Style 51100 N (screw, countersunk head No. 22524, screw, fillister head, No. 22585 A) - - -	15
51282 M	Oil Reservoir Top Cover Gasket- - - - -	15
51282 N	Oil Reservoir Top Cover Oil Drip Plate, for Style 51100 N (screw No. 187 A) - - - - -	11
51282 R	Oil Reservoir Back Cover, for Style 51100 N (screw No. 22848) - - - - -	15
51282 S	Oil Reservoir Back Cover Gasket - - - - -	15

LIST OF PARTS

Symbol to Order By	The figures in the last column refer only to the plates illustrating the parts and are not to be used in ordering. Prices furnished on application.	Plate No.
51282 T	Crankshaft Chamber Cover, right, for Style 51100 N and left, for Style 51000 A (screw No. 90) - - - - -	11
51282 U	Crankshaft Chamber Cover Gasket- - - - -	11
51290	Main Shaft Bushing, inner right, 3/4 inch long, for Style 51000 A, also inner left bushing for Style 51100 N- - - - -	5
51290 A	Main Shaft Bushing, outer left, 1 9/32 inch long, for Style 51000 A; also outer right bushing for Style 51100 N- - - - -	5
51290 D	Main Shaft Bushing, right, 3/4 inch long, for Style 51000 A; also left bushing for Style 51100 N- - - - -	5
51290 E	Main Shaft Bushing, middle - - - - -	5
*51290 P	Main Shaft Bushing Housing, includes bushing (screw No. 22569 B)- - - - -	9
51292	Tension Post - - - - -	7
51292 C	" Regulating Nut - - - - -	4
51292 F-1	Tension Spring, .016 inch diameter wire, for looper thread- - - - -	6
51292 F-2	" " .022 inch diameter wire, for looper thread- - - - -	6
51292 F-8	" " .037 inch diameter wire, for needle thread- - - - -	6
51292 F-14	" " .047 inch diameter wire, for needle thread- - - - -	6
51293 M	Looper Rocker Stud Oil Tube, for Style 51100 N (screw No. 22829, coupling No. 61294 X) - - - - -	12
51293 Q	Left Main Shaft Bearing Oil Tube, for Style 51100 N (coupling No. 61294 X) - - - - -	12
51294 F	Oil Tube Coupling, for attaching oil tubes to oil reservoir - - - - -	7
51722	Main Shaft, left section, for Style 51100 N	14
51741 E	Washer, for looper connecting rod ball joint assemblies Nos. 51041 D, 51241 G - - - - -	4
51745	Looper Rocker Cone Stud- - - - -	6
51751	Presser Bar Guide (screw No. 22560 B)- - - - -	2
51758	Frame Needle Thread Eyelet, intermediate (attaching screw No. 22848, adapter screw No. 22840, washer No. 20)- - - - -	6
52834 N	Looper Drive Ball Joint Locking Stud Nut - -	4
52841	" " " " " " " " - - - - -	7
52882 E	Upper Crank Chamber Cover Gasket - - - - -	15
52887	Presser Spring (locating screw No. 35768 A)	13
52887 G	" " Rest- - - - -	6
52888	" Bar- - - - -	13
52889	" " Bushing, upper - - - - -	5
55235 D	Feed Rocker Arm Locking Stud, for Nos. 51035 A, 51135 P - - - - -	7
55235 E	Feed Rocker Arm Locking Stud Nut - - - - -	4

\*See Page 5

LIST OF PARTS

Symbol to Order By	The figures in the last column refer only to the plates illustrating the parts and are not to be used in ordering. Prices furnished on application.	Plate No.
#55241 N	Looper Connecting Rod Ball Joint Assembly, left, for Style 51100 N equipped with looper drive lever No. 51242 N (bearing screw No. 97 A, nut No. 18) - - - - -	2
K56749	Looper Thread Take-up, for Style 51100 N (spot screw No. 96, set screw No. 22580) - - - - -	10
K56750	Cast-off Wire Support, for Style 51100 N (screw No. 22528, washer No. 21657 E) - - - - -	13
K56755	Throat Plate Support, for Style 51100 N (screw No. 22839) - - - - -	14
K56760	Throat Plate Support Pin Holder, for Style 51100 N - - - - -	5
K58614	Throat Plate, for Style 51100 N (screw No. 22570) - - - - -	1
K58615	Feed Dog, lower, for Style 51100 N (screw No. 22528) - - - - -	1
K59048	Feed Rocker Oil Tube, also feed lift and loop- er avoid eccentric oil tube, for Style 51100 N (coupling No. 61294 X) - - - - -	11
K59292	Needle Lever Link Pin Oil Tube, for Style 51100 N (screw, right, No. 22595, screw, left, No. 22849) - - - - -	12
K59837	Cloth Plate, for Style 51100 N (screw No. 80)	17
K60323	Feed Rocker, with .470 inch diameter stem, for Style 51100 N (screw No. 98) - - - - -	10
K60324	Feed Rocker Arm, with .468 inch diameter hole, for Style 51100 N (clamp screw No. 22519 C, clamp screw washer No. 51235 G) - - - - -	9
K60325	Feed Rocker, with .470 inch diameter stem, for Style 51000 A (screw No. 98) - - - - -	10
K60326	Feed Rocker Arm, with .468 inch diameter hole, for Style 51000 A (clamp screw No. 22519 C, clamp screw washer No. 51235 G) - - - - -	9
61294 X	Coupling, for oil line tubes - - - - -	4

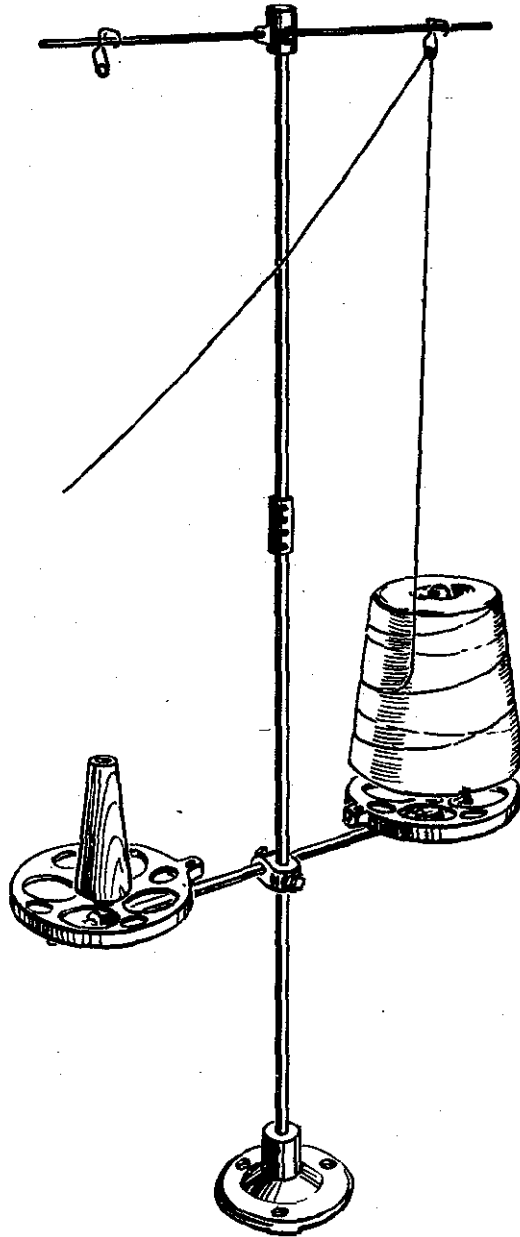

THREAD STAND ASSEMBLY FOR  
STYLES 51000 A, 51100 N



## ANALYSIS OF COMPARATIVE SEWING COSTS

This form offers a simple method for you to determine the effect of modern, high speed machines on your production and overhead costs. To use it, merely fill in the starred items. Any Union Special representative will supply the necessary information on the improved machine which will enable you to complete the record.

\*Sewing Operation \_\_\_\_\_

\*PRESENT MACHINE Style \_\_\_\_\_

IMPROVED MACHINE Style \_\_\_\_\_

<p><b>*1. Average Daily Production per Machine.....</b> Doz. (From your own records.)</p> <hr/> <p><b>*2. SEWING COST</b></p> <p><b>*Average Daily Earnings per Operator.....</b> \$ (From your own records.)</p> <p><b>*Average Daily Overhead per Operator.....</b> \$ (Determine your overhead as a percentage of direct labor from your own records. Multiply the average daily earnings per operator shown above by this percentage.)</p> <p><b>*Total Daily Sewing Cost per Operator.....</b> \$ (This is the sum of earnings and overhead as determined above.)</p> <p><b>*Sewing Cost per Dozen.....</b> \$ (Divide the total daily sewing costs per operator by the average daily production with your present machine.)</p> <hr/> <p><b>3. SAVINGS EFFECTED</b></p> <p><b>Per Dozen Garments.....</b> \$ (Subtract the sewing cost per dozen expected with the improved machine from your present sewing cost per dozen.)</p> <p><b>Per Day.....</b> \$ (Multiply the savings per dozen determined above by the production expected from the improved machine.)</p> <p><b>Per Year.....</b> \$ (Multiply the savings per day by 240 days.)</p> <p><b>Less 10% depreciation on net cost of new machine.....</b> \$</p> <p><b>Net Annual Saving.....</b> \$</p>	<p><b>1. Add.....%</b> (due to increased efficiency of improved machine) to the production shown in the opposite column. Expected production of the new machine is thus..... Doz.</p> <hr/> <p><b>2. SEWING COST</b></p> <p><b>Average Daily Earnings per Operator.....</b> \$ (Increased production from improved machine should enable operator's earnings to be increased up to 10%. Add ____% to average daily earnings shown in opposite column.)</p> <p><b>Average Daily Overhead per Operator.....</b> \$ (This is the same as the average daily overhead shown in the opposite column, as dollar overhead is not affected when production per machine is increased.)</p> <p><b>Total Daily Sewing Cost per Operator.....</b> \$ (This is the sum of earnings and overhead as determined above.)</p> <p><b>Sewing Cost per Dozen.....</b> \$ (Divide the total daily sewing cost per operator by the average daily production expected from the new machine.)</p> <hr/> <p><b>4. REPLACEMENT COST</b></p> <p><b>Cost of improved machine.....</b> \$</p> <p>Less trade-in or resale value present machine..... \$</p> <p>Less overhauling or repair present machine..... \$</p> <p><b>Net cost improved machine.....</b> \$</p> <hr/> <p><b>5. SUMMARY</b></p> <p><b>Number of operating days required to repay net cost.....</b> Days (Divide the net cost of improved machine by the annual savings. Multiply this result by 240 days.)</p> <p><b>Annual return on net cost.....</b> % (Divide the annual savings by the net cost.)</p> <p>(Additional copies of this form, size 8½ x 11", available in quantities at cost.)</p>
---	---

101

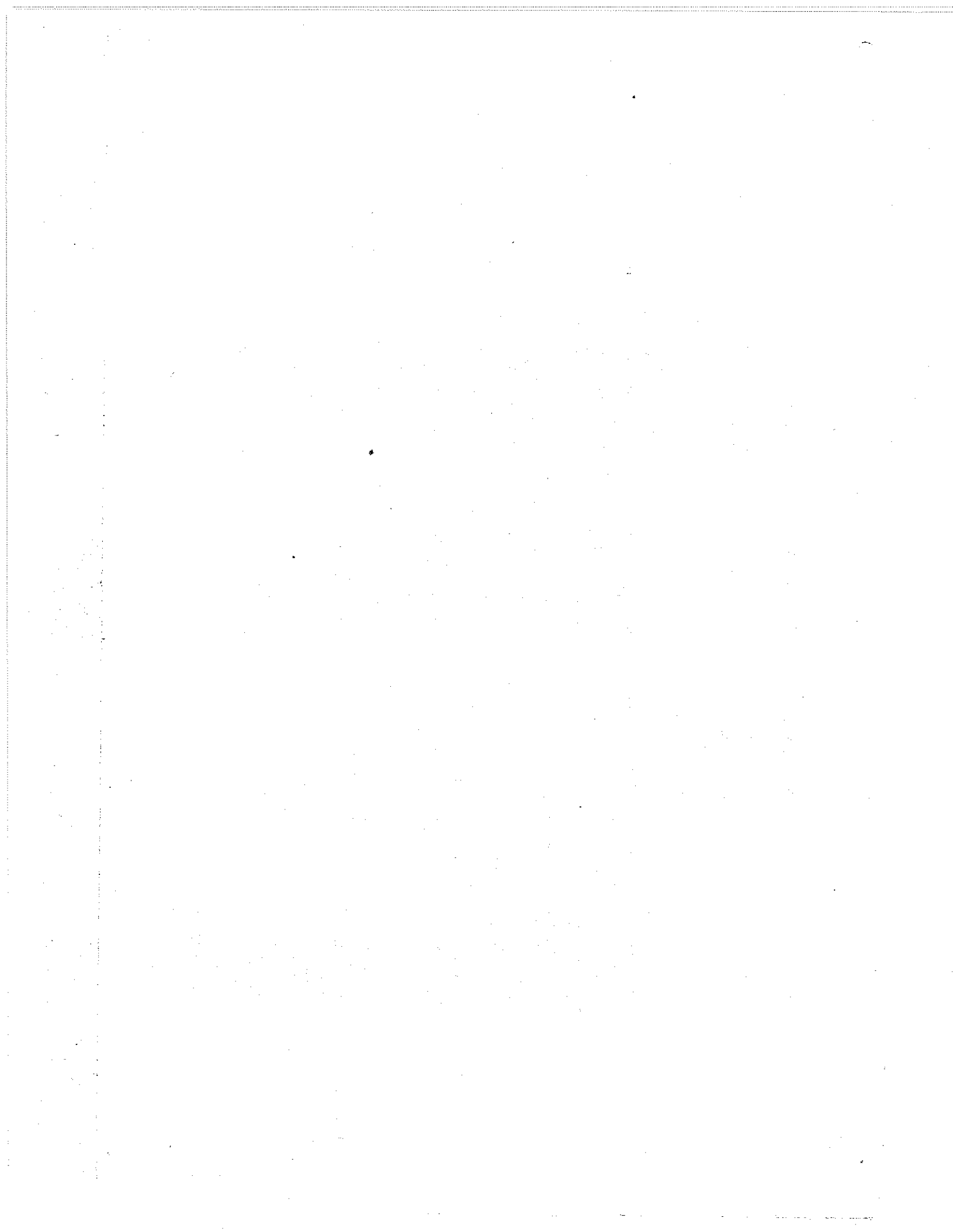

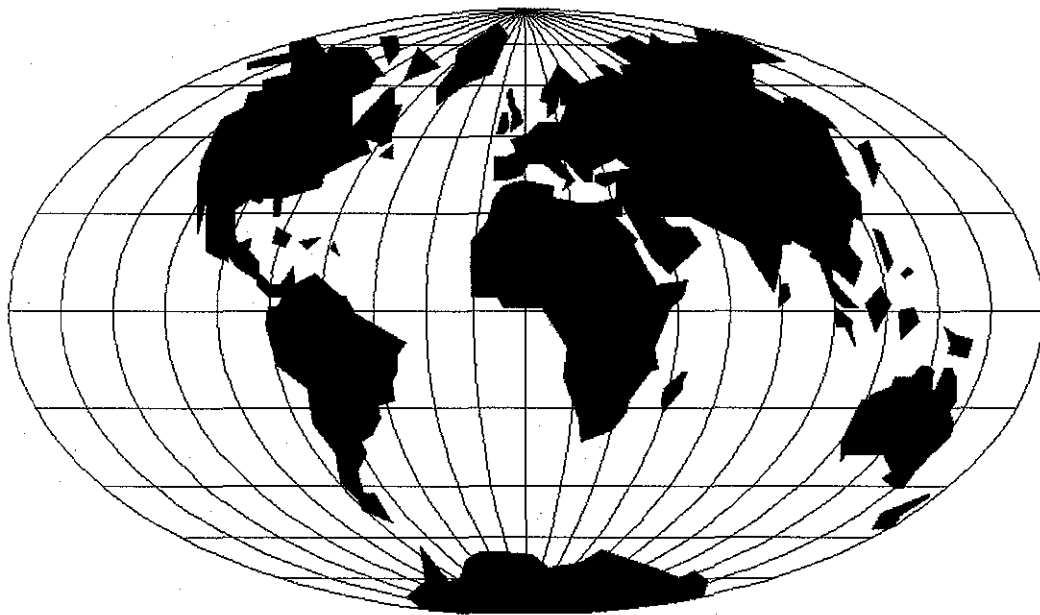

## WORLDWIDE SALES AND SERVICE

Union Special Corporation maintains sales and service facilities throughout the world. These offices will aid you in the selection of the right sewing equipment for your particular operation. Union Special Corporation representatives and service technicians are factory trained and are able to serve your needs promptly and efficiently. Whatever your location, there is a qualified representative to serve you.

---

**Corporate Office:** One Union Special Plaza  
Huntley, IL 60142  
Phone: 847•669•5101  
Fax: 847•669•1096

**European Distribution Center:** Union Special GmbH  
Raiffeisenstrasse 3  
D-71696 Möglingen, Germany  
Tel: 49•07141•247•0  
Fax: 49•7141•247•100

Brussels, Belgium  
Charlotte, N.C.  
El Paso, TX  
Hong Kong, China  
Huntley, IL  
Leicester, England  
Lille, France  
Miami, FL  
Milan, Italy  
Möglingen, Germany  
Montreal, Quebec  
Osaka, Japan  
Santa Fe Springs, CA

Other Representatives throughout  
all parts of the world.



*Union Special*  
INDUSTRIAL SEWING EQUIPMENT

